

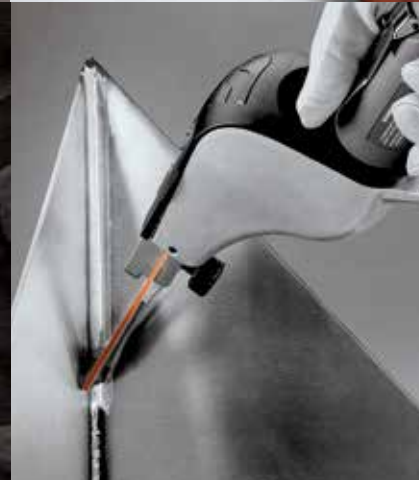

# DYNABRADE ABRASIVE SYSTEM PRODUCTS



**WE LISTEN. WE OBSERVE. WE OPTIMIZE.**







For more than 50 years, Dynabrade has earned a reputation for excellence and a position of leadership in the innovative design and manufacturing of unique portable pneumatic abrasive power tools, related accessories, and dust collection. With our total systems solutions offerings, we are able to meet the specific needs of many industries. Our products are used in a variety of applications on nearly any material that requires surface preparation and finishing. We are easy-to-do business with and supply these products quickly to customers through a worldwide network of professional distributors.



**WE LISTEN. WE OBSERVE. WE OPTIMIZE.**

## DYNABRADE EUROPE

**Established in 1989**, Dynabrade Europe is the Luxembourg-based office for Europe, Middle East and Africa (**more than 77 countries**) providing Sales, Marketing, Customer Service, Warehousing and Repair services for the Dynabrade product range.

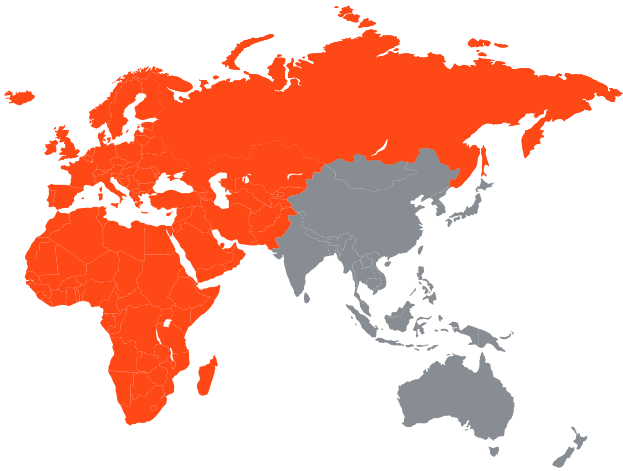

**Dynabrade Customer Service in Europe** is capable to respond to any request in more than **10 different languages**

## THE DYNABRADE DIFFERENCE

### TOOLS & PROCESS SOLUTIONS



**INNOVATION**



**ENGINEERING**



**PRODUCTION**



**TECHNICAL SUPPORT**

### INDUSTRY APPLICATION EXPERTS

Our experts optimize abrasive specialty applications applying 50 years of hands-on, industry-specific experience and data, improving productivity and/or surface finishes.

## INDUSTRIES



**AEROSPACE & DEFENSE**



**AUTOMOTIVE OEM AND TIER1**



**MARINE & SHIPYARD**



**WELDING**



**WIND ENERGY**



**WOODWORKING**



**METAL WORKING**



**AUTOMOTIVE AFTERMARKET**

## SURFACES

Our tools & solutions are developed to be used on a variety of Materials : stainless **steel**, **wood**, **fiberglass**, **aluminum**, **cast iron**, **non-ferrous metals**, **exotic metals**, **glass**, **ceramics**, **stone**, **composites** and more!

## PRODUCTS

The product range includes a wide variety of tools for different surface preparation & finishing applications

### POWER TOOLS (AIR & ELECTRIC) – 1200+ MODELS

- Abrasive Belt and Finishing Tools
- Random Orbital Sanders
- General Purpose Tools

### DUST COLLECTION & DOWNDRAFT TABLES – 50+ MODELS

- Dry Vacuums
- Downdraft Tables & Stations
- Wet Filtration
- Air & Electric Portable Vacuums

### STATIONARY MACHINES

- Grinding
- Superfinishing

### ABRASIVES – 1250+ PRODUCTS

- Full Line of Specialty Abrasives & Compounds

### ACCESSORIES

- All the necessary items to run & maintain your Dynabrade tools such as back-up pads, contact arms, etc...

### EASY-TO-DO-BUSINESS



**CUSTOMER SUPPORT**



**FAST SHIPPING**



**DROP SHIPMENT OPTION**



**SOLUTION ORIENTED**

### TRUST

Our customers and channel partners trust us, resulting in strong, lasting and mutually beneficial relationships.

## COATED ABRASIVES

Coated Abrasive Belts .....	6-13
Coated Abrasive Films & Paper Discs .....	14-31
- DV722 Discs & Sheets .....	15-18
- DV722 Rolls .....	19
- DV522 Gold .....	19
- DG922 Abrasive Discs .....	20-25
- DG922 Daisy Discs .....	26
- DG922 Rolls .....	26
- Clog Free Soft Film Discs .....	27-28
- DG997 Ceramic Films Discs & Jumbo Rolls ..	29
- Dynamesh Discs .....	31
- Dynamesh Jumbo Rolls .....	32
- DM555 Soft Sanding Discs .....	33
Coated Locking Type Discs .....	34-37
- DC321 Locking-Type Fiber Discs .....	35
- DC321 Dynafire Locking-Type Fiber Discs .....	36
Coated Flap Discs .....	38-39
- Locking-Type Flap Discs .....	39
Coated Fiber Discs .....	41-43
- DV737 Ceramic Discs .....	41
- Dynafire Flange Mount .....	42
- DQ215 Cotton Fiber Discs .....	43
Coated Specialties .....	44-47
- Sanding Stars .....	45-46
- Cartridge Rolls .....	47

## NON-WOVEN ABRASIVES

Non-Woven Abrasive Belts .....	48-51
- Surface Conditioning Belt .....	49-51
Non-Woven Abrasive Discs .....	52-55
- DS323R Surface Conditioning Discs .....	52-53
- DU312F & DU368R Unitized Discs .....	54-55
Non-Woven Abrasive Specialties .....	56-59
- Shaft Mandrel .....	56
- DB357 Oxide Removal Abrasives .....	57
- D0379 Oxide Removal Discs .....	57
- DB-FB & DP-FB Plastic Core Flap Brushes .....	58

## STRUCTURED ABRASIVES

Structured Abrasives Discs & Rolls .....	60-63
- Cloth Backed .....	61
- Dynasaf .....	62
- Dynasaf 379 YB .....	63

## DYNABURR™ CARBIDE BURRS

Carbide Burrs .....	64-67
---------------------	-------

## BONDED ABRASIVES

<b>Bonded Abrasives</b> .....	<b>68-69</b>
- Cut-Off Discs .....	<b>69</b>

## POLISHING

<b>Polishing Products</b> .....	<b>70-79</b>
- Dynacoarse .....	<b>71</b>
- Dynablue .....	<b>72</b>
- Dynateal .....	<b>72</b>
- Dynaorange .....	<b>73</b>
- Denibbing Discs .....	<b>73</b>
- Pads & Foams .....	<b>74-75</b>
- Cylindrical Reticulated Foams .....	<b>75</b>
- Conical Reticulated Foams .....	<b>76</b>
- 5L Container Accessories .....	<b>77</b>
- Microfiber Wipes .....	<b>77</b>
- Polishing Foam Tube Holder .....	<b>77</b>
- Dynamirror .....	<b>78</b>

## MICRO & SUPERABRASIVES

<b>Microabrasives &amp; Superabrasives</b> .....	<b>80-85</b>
- DLF 300 Lapping Film Rolls .....	<b>81</b>
- DCLF300 Diamond SC lapping Film Rolls .....	<b>81</b>
- DMF 500 Microfinishing Film Rolls .....	<b>82</b>
- DMF 300 Microfinishing Film Rolls .....	<b>82</b>
- DDMF 500 Diamond Microfinishing Film Rolls .....	<b>82</b>
- DDLF 400 Diamond Microfinishing film Rolls .....	<b>83</b>
- DDLF 300 Diamond lapping film Rolls .....	<b>83</b>
- Dynamond Superabrasives .....	<b>84</b>
- Dynamond Spiraband .....	<b>84</b>
- Dynamond Strips .....	<b>85</b>
- Dynamond Belts .....	<b>85</b>

## MISCELLANEOUS

<b>Miscellaneous</b> .....	<b>86-89</b>
- Bi-Metal Saw Blades .....	<b>87</b>
- Nitro Saw Blades .....	<b>87</b>
- Reciprocating Files .....	<b>88</b>
- Diamond Cut-Off Wheels .....	<b>89</b>
- Diamond Blades .....	<b>89</b>

## COATED ABRASIVE BASICS

## GLOSSARY

<b>Grit Grading Systems</b> .....	<b>93</b>
<b>Conversion Table</b> .....	<b>94</b>

# COATED ABRASIVE BELTS



## COATED ABRASIVE BELTS

Dynabrade is the company that created the first portable power tool solution for the grinding and finishing of difficult to reach areas. The Dynaflex® Dynabrade's DC 242 coated

abrasive belt offering is a multi-tiered line engineered to deliver maximum benefit on virtually any application. The Dynaflex® II coupled with DC 242 belts are the ideal solution for grinding and finishing

in hard to reach areas like grinding away spot welds for faster tear down, grinding and blending welds on framing, tubing, exhaust and other components.

## DC242 COATED ABRASIVE BELTS CLOTH BACKING | 27-33 M/S RECOMMENDED SPEED

### APPLICATIONS

- ▶ Grinding and sanding on metals, composites, plastics, wood with Dynabrade belt tools.

### FEATURES

- ▶ Available in: Zirconia Alumina with grinding aid and Aluminum oxide.
- ▶ Zirconia Alumina with grinding aid grits are for heavy stock removal to intermediate finish.
- ▶ Excellent on stainless steel, carbon steel, cast iron, exotic alloys, Aluminum, bronze and brass.
- ▶ Grinding Aid – a chemical that reduces the temperature of the working area, minimizing the risk of discoloration and deformation, in particular on stainless steel metal fabrication.
- ▶ Aluminum oxide grits are for general purpose finishing applications on any kind of metals and alloys.

### TARGET MARKETS

- ▶ Metal Fabrication, Casting and Forging, Woodworking, AOEM, AAM, Marine, Composites.

INFORMATION

DC242 COATED ABRASIVE BELTS CLOTH BACKING | 27-33 M/S RECOMMENDED SPEED

Width (mm)	Length (mm)	Grit	Mineral	P/N	Qty/Box
3	305 mm	60	Z/A	70003	30
		80		70004	
		120		70006	
		180	A/O	70008	
		240		70009	
		320		70010	
	457 mm	60	Z/A	70015	
		80		70016	
		120		70018	
		180	A/O	70020	
		240		70021	
		320		70022	
	610 mm	60	Z/A	70027	
		80		70028	
		120		70030	
		180	A/O	70032	
		240		70033	
		320		70034	
6	1829 mm	60	Z/A	72850	10
		80		72851	
		120		72853	
		180	A/O	72856	
		240		72858	
		320		72859	
6	305 mm	60	Z/A	70903	30
		80		70904	
		120		70906	
		180	A/O	70044	
		240		70045	
		320		70046	
	457 mm	60	Z/A	70910	
		80		70911	
		120		70913	
		180	A/O	70056	
		240		70057	
		320		70058	
610 mm	60	Z/A	70917		
	80		70918		
	120		70920		
	180	A/O	70068		
	240		70069		
	320		70070		





**DC242 COATED ABRASIVE BELTS - CLOTH BACKING**

27-33 M/S RECOMMENDED SPEED

Width (mm)	Length (mm)	Grit	Mineral	P/N	Qty/Box
13	1829 mm	60	Z/A	72860	10
		80		72861	
		120		72863	
		180	A/O	72866	
		240		72868	
		320		72869	
	305 mm	60	Z/A	70931	30
		80		70932	
		120		70934	
		180	A/O	70092	
240		70093			
320		70094			
13	330 mm	60	Z/A	24612	
		80		24613	
		120		24614	
		180	A/O	24615	
		240		24616	
		320		24617	
13	457 mm	36	Z/A	24501	30
		40		24502	
		60		70938	
		80		70939	
		120		70941	
		180		A/O	
		240	70105		
		320	70106		
		60	CER		
		80		22230	
120	24625				



EXAMPLE WITH : 15300

**THE "ORIGINAL" DYNAFILE®**

**APPLICATION SOLUTIONS**

World-famous 14000 Dynafile® replaces tedious hand-sanding and filing in an endless array of applications. In this photo the Dynafile® is powering an optional 11237 Contact Arm, ideal for working in areas as small as 3/8" (10mm). The arm is also utilized for turbine blade grinding, blending and polishing.



DC242 COATED ABRASIVE BELTS CLOTH BACKING | 27-33 M/S RECOMMENDED SPEED

Width (mm)	Length (mm)	Grit	Mineral	P/N	Qty/Box	
13	610 mm	60	Z/A	70945	30	
		80		70946		
		120		70948		
		180	A/O	70116		
		240		70117		
		320		70118		
19	457 mm	36	Z/A	73372		
		40		70951		
		60		70952		
		80	A/O	70953		
		120		70955		
		180		70128		
19	520 mm	240	A/O	70129	10	
		320		70130		
		40		CER		22353
		60	22354			
		60	Z/A	70959		
		80		70960		
120	70962					
25	1524 mm	180	A/O	70140		
		240		70141		
		320		70142		
		40		22662		
		60		22663		
		80		22664		
25	829 mm	100	A/O	22665	10	
		120		22666		
		150		22667		
		180	Z/A	22668		
		220		22669		
		60		72870		
25	457 mm	80	Z/A	72871		30
		120		72872		
		180		72873		
		240	A/O	72874		
		320		72875		
		60		Z/A		
80	70981					
120	70983					
25	457 mm	180	A/O	70164		
		240		70165		
		240	Z/A	70166		
		320		70166		



EXAMPLE WITH : 40320



EXAMPLE WITH : 15300

**DC242 COATED ABRASIVE BELTS - CLOTH BACKING**

27-33 M/S RECOMMENDED SPEED

Width (mm)	Length (mm)	Grit	Mineral	P/N	Qty/Box	
25	610 mm	60	Z/A	73031	30	
		120		73032		
		180	A/O	73033		
25	762 mm	60	Z/A	71001	10	
		80		71002		
		120		71004		
		180	A/O	70200		
		240		70201		
		320		70202		
		40		Z/A		72903
60	73306					
80	73308					
38	762 mm	120	Z/A	73310	10	
		180		73408		
		220		73410		
		320	A/O	73412		
		400		24540		
		600		24541		
		240		24546		
		40		CER		22348
		60				22349
		80				73508
		120				73510
50	1143 mm	60	Z/A	73182	10	
		80		73183		
		120		73184		
50	1143 mm	180	A/O	73185	10	
		240		73186		
		320		73187		
50	1220 mm	36	Z/A	22274	10	
		40		22275		
		60		22276		
		80		22277		
		120	A/O	22278		
		180		22279		
		240		22280		
50	762 mm	320	Z/A	22281	10	
		400		22282		
		600		22283		
		60		71029		
		80		71030		
		120		71032		



EXAMPLE WITH : 11476

DC242 COATED ABRASIVE BELTS CLOTH BACKING | 27-33 M/S RECOMMENDED SPEED



Width (mm)	Length (mm)	Grit	Mineral	P/N	Qty/Box			
50	762 mm	180	A/O	70248	10			
		240		70249				
		320		70250				
50	864 mm	40	CER	22351	10			
		60		22352				
		36	Z/A	24570				
		60		72249				
		80		72250				
		50	920 mm	120		Z/A	72251	10
				180			72895	
240	A/O			72896				
320				72897				
50	920 mm			40	Z/A		73028	
		60	73029					
		80	73030					
		80	72876					
75	610 mm	80	Z/A	72877	10			
		120		72878				
		180		A/O		72880		
		240				72881		
		320		72882				
76	272 mm	36	Z/A	73440	10			
		60		72889				
		80		72890				
		120	72892					
		180	A/O	72893				
240	72894							
		320		73082				



EXAMPLE WITH : 14000



**DYNAFILE® III**  
SLACK POLISHING APPLICATION

15300 Dynafite® III  
Utilizing 1" wide abrasive belts and the slack portion of the contact arm. The Dynafite® III easily blends and polishes bends in pipes while maintaining original dimensions. The added horsepower provided by the .7 hp motor in the Dynafite® III efficiently powers 1" wide belts in both grinding and polishing applications.





**DC242 COATED ABRASIVE BELTS - CLOTH BACKING**

27-33 M/S RECOMMENDED SPEED



Width (mm)	Length (mm)	Grit	Mineral	P/N	Qty/Box
89	394 mm	60	Z/A	72883	10
		80		72884	
		120		72885	
		180	A/O	72886	
		240		72887	
		320		72888	
100	289 mm	60	Z/A	73083	
		80		73084	
		120		73085	
		180	A/O	73086	
		240		73087	
		320		73088	



# COATED ABRASIVE FILMS & PAPER DISCS



## FILM / PAPER DISCS, DISC ROLLS AND SHEETS

At Dynabrade we listen, we observe, and we optimize. There are a wide variety of sanding and finishing applications in today's modern body, fabrication and detail shops. Dynabrade offers a full selection of premium performance film and paper backed

discs and sheets providing an optimum solution for virtually any sanding and finishing application. DV 722 Sanding and Finishing abrasives include hook-face discs and sheets. These sanding and finishing abrasives are commonly used for stripping

paint, sanding plastics, fiberglass and composites, leveling and blending body filler, feather edging and sanding primer, color and clear coat.

## DV722 COATED ABRASIVE DISCS & SHEETS – ALUMINUM OXIDE PAPER BACKING

### APPLICATIONS

- ▶ Surface sanding on any type of wood, metal, composite, solid surface, filler, e-coat, primer, paint coat, clear coat and gel coat.

### FEATURES

- ▶ Anti-loading stated topcoat provides long life and good cut rate without wild scratches.
- ▶ Hook-Face Attachment.
- ▶ Open coat of Aluminum oxide grain for less clogging.
- ▶ Suitable for grinding new generation water based lacquers.

### BENEFITS

- ▶ Resinoid bonding ensures excellent performance and durability.
- ▶ Excellent dust reduction with vacuum dust extraction system for a safe and work-friendly environment.

### TARGET MARKETS

- ▶ Metal Fabrication, Casting and Forging, Woodworking, AOEM, AAM, Marine, Composites.

INFORMATION



Diameter/Size	Grit	Holes	P/N	Qty/Box
75 mm	80	6	22239	50
	100		22241	
	120		22258	
	150		22259	100
	180		22260	
	240		22261	
	320		22262	
	400		22263	
	600		22264	
150 mm	800	15	22265	50
	60		24644	
	80		24645	
	100		24646	
	120		24647	
	150		24648	100
	180		24649	
	220	24650		



EXAMPLE WITH : X31V

## DV722 COATED ABRASIVE DISCS & SHEETS - ALUMINUM OXIDE PAPER BACKING

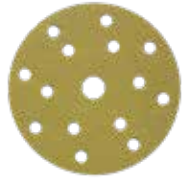

Diameter/Size	Grit	Holes	P/N	Qty/Box
150 mm	240	15	24651	100
	280		24652	
	320		24653	
	360		24654	
	400		24655	
	500		24656	
	600		24657	
	800		24658	
150 mm	60	7	24682	50
	80		24683	
	100		24684	
	120		24685	
	150		24686	
	180		24687	100
	220		24688	
	240		24689	
	280		24690	
	320		24691	
150 mm	360	0	24692	50
	400		24693	
	500		24694	
	600		24695	
	800		24696	
	60		24629	50
	80		24630	
	100		24631	
	120		24632	
	150		24633	
150 mm	180	0	24634	100
	220		24635	
	240		24636	
	280		24637	
	320		24638	
	360		24639	100
	400		24640	
	500		24641	
	600		24642	
	800		24643	
80 x 130 mm	180	0	22595	100
	240		22572	
	320		22593	
	400		22618	
	500		22619	





**DV722 COATED ABRASIVE DISCS & SHEETS - ALUMINUM OXIDE PAPER BACKING**  
 C/B WEIGHT PAPER BACKING WITH HOOK-FACE ATTACHMENT | 13,000 RPM MOS | ALUMINUM OXIDE

Diameter/Size	Grit	Holes	P/N	Qty/Box
80 x 130 mm	80	8	22266	50
	120		22267	
	180		22268	100
	240		22269	
	320		22270	
70 x 198 mm	80	8	22231	50
	120		22232	
	180		22233	100
	240		22234	
	320		22235	
	400		22236	
95 x 175 mm	80	10	22207	50
	120		22208	
	180		22209	100
	240		22210	
	320		22211	
	400		22212	
100 x 150 mm	80	7	22225	50
	120		22226	
	180		22227	100
	240		22228	
	320		22229	
83 x 83 x 83 mm	80	0	22219	50
	120		22220	
	180		22221	100
	240		22222	
	320		22223	
	400	22224	50	
	80	6		22213
	120			22214
	180			22215
	240			22216
320	22217			
	400		22218	100



DV722 COATED ABRASIVE DISCS & SHEETS – ALUMINUM OXIDE PAPER BACKING

Diameter/Size	Grit	Holes	P/N	Qty/Box
62 x 98 mm	80	0	22012	50
	120		22026	
	180		22028	100
	320		22032	
	400		22034	
	500		22036	
62 x 98 mm	80	6	22039	50
	120		22041	100
	180		22043	
	320		22205	
70 x 198 mm	400	10	22206	100
62 x 98 mm	120	10	22237	100
	100		22328	
62 x 98 mm	240	0	22329	100
	240	6	22355	100
	400	7	22356	
80 x 400 mm	60	14	22384	100
	80		22385	
	120		22386	
	180		22387	
	240		22388	
	320		22389	
115 x 400 mm	60	14	22390	100
	80		22391	
	120		22392	
	180		22393	
	240		22394	
115 x 280 mm	320	10	22395	50
	60		22464	
	80		22465	
	120		22466	100
	180		22467	
	240		22468	
	320		22469	



: 57900



## DV722 COATED ABRASIVE ROLLS – ALUMINUM OXIDE PAPER BACKING

Size	Grit	Holes	P/N	Qty/Box
335 mm x 25 mt	240	0	22271	1
	280		22272	
	320		22273	

## DV522 GOLD COATED ABRASIVE DISCS – ALUMINUM OXIDE PAPER BACKING

Similar Quality as DV722 for a lower price

Diameter	Grit	Holes	P/N	Qty/Box
150 mm	60	15	71330	100
	80		71331	
	120		71332	
	150		71333	
	180		71334	
	240		71335	
	320		71336	
	400		71337	
150 mm	150	0	71343	100
	400		71347	

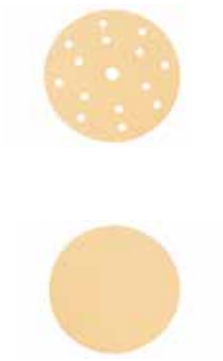

## DG922 COATED ABRASIVE DISCS ALUMINUM OXIDE FILM BACKING

### APPLICATIONS

- ▶ Surface sanding on any type of wood, metal, composite, solid surface, filler, e-coat, primer, paint coat, clear coat and gel coat.

### FEATURES

- ▶ Aluminum oxide mineral together with film backing gives a very controlled and even sanding property.
- ▶ Hook-Face Attachment
- ▶ Easily convertible from paper disc for better quality and longer life. Ideal for both dry and wet applications.

### BENEFITS

- ▶ Polyester film backing allows long-lasting application time and better resistant to tear-off in difficult corners.
- ▶ Anti-loading treatment greatly enhances the life of the product and also improves work piece finish.
- ▶ Film works better than paper with uniform mineral coating on perfectly even film surface.

### TARGET MARKETS

- ▶ Metal Fabrication, Casting and Forging, Woodworking, AOEM, AAM, Marine, Composites.

INFORMATION

Diameter/Size	Grit	Holes	P/N	Qty/Box
19 mm	80	0	73908	500
	120		73909	
	150		73910	
75 mm	1000	0	22956	100
	1500		22556	
	2000		22474	
75 mm	40	6	73147	100
	60		73148	50
	80		73820	
	100		73821	
	120		73822	
	150		73823	
	180		73824	
	220		73825	
	240		73826	
	280	73113		
	320	73114		
	400	73115		
	500	73116		
	600	73117		
	800	73827		
	1000	73828		
	1200	73829		
	1500	73830		
	2000	73831		
90 mm	40	0	73720	50
	60		73721	





## DG922 COATED ABRASIVE DISCS ALUMINIUM OXIDE FILM BACKING

Diameter/Size	Grit	Holes	P/N	Qty/Box
90 mm	80	0	73722	100
	100		73723	
	120		73724	
	150		73725	
	180		73726	
	220		73727	
	240		73728	
	280		73729	
	320		73730	
	360		73349	
	400		73731	
	500		73119	
	600		73732	
	800		73141	
	1000		73142	
	1200		73143	
1500	73144			
2000	73145			
125 mm	40	0	73520	50
	60		73521	
	80		73522	
	100		73523	
	120		73524	
	150		73525	
	180		73526	
	220		73527	
	240		73528	
	280		73529	
	320		73530	
	400		73531	
500	73533			
600	73534			
800	73535			
1000	73536			
1200	73537			
1500	73538			
2000	73539			
125 mm	40	17	73988	50
	60		73989	
	80		73295	100
	100		73946	
	120		73947	



EXAMPLE WITH : X32



EXAMPLE WITH: X51H



EXAMPLE: 59024

**DG922 COATED ABRASIVE DISCS & SHEETS – ALUMINUM OXIDE FILM BACKING**  
 FILM BACKING WITH HOOK-FACE ATTACHMENT | 13,000 RPM MOS | ALUMINUM OXIDE

Diameter/Size	Grit	Holes	P/N	Qty/Box
125 mm	150	17	73948	100
	180		73996	
	220		73997	
	240		73998	
	280		73999	
	320		73149	
	360		73241	
	400		73992	
	500		73993	
	600		73994	
	800		73995	
	1000		73247	
	1200		73248	
	1500		73249	
2000	73341			
125 mm	40	9	73620	50
	60		73621	
	80		73622	
	100		73623	
	120		73624	
	150		73625	
	180		73626	
	220		73627	
	240		73628	
	280		73629	
	320		73630	
	360		73647	
	400		73631	
	500		73648	
600	73632			
800	73649			
1000	73243			
1200	73244			
1500	73245			
2000	73246			
150 mm	40	15	73120	50
	60		73121	
	80		73122	
	100		73123	
	120		73124	
	150		73125	
	180		73126	
	220		73127	



EXAMPLE WITH: 58405



## DG922 COATED ABRASIVE DISCS ALUMINUM OXIDE FILM BACKING

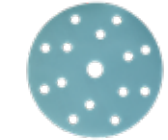

Diameter/Size	Grit	Holes	P/N	Qty/Box
150 mm	240	15	73128	100
	280		73129	
	320		73130	
	360		73131	
	400		73132	
	500		73133	
	600		73134	
	800		73135	
	1000		73136	
	1200		73137	
	1500		73138	
	2000		73139	
150 mm	40	0	73220	50
	60		73221	
	80		73222	
	100		73223	
	120		73224	
	150		73225	
	180		73226	100
	220		73227	
	240		73228	
	280		73229	
	320		73230	
	360		73231	
400	73232			
500	73233			
600	73234			
800	73235			
1000	73236			
1200	73237			
1500	73238			
2000	73239			
200 mm	40	8	73320	50
	60		73321	
	80		73322	100
	100		73323	
	120		73324	
	150		73325	
	180		73326	
	220		73327	
240	73328			



EXAMPLE WITH: 59040



EXAMPLE : 58660



**DG922 COATED ABRASIVE DISCS - ALUMINUM OXIDE FILM BACKING**

FILM BACKING WITH HOOK-FACE ATTACHMENT | 13,000 RPM MOS | ALUMINUM OXIDE

Diameter/Size	Grit	Holes	P/N	Qty/Box
200 mm	280	8	73329	100
	320		73330	
	360		73331	
	400		73332	
	500		73333	
	600		73334	
	800		73335	
	1000		73336	
	1200		73337	
	1500		73338	
	2000		73339	
	200 mm		40	
60		73421		
80		73422		
100		73423	100	
120		73424		
150		73425		
180		73426		
220		73427		
240		73428		
280		73429		
320		73430		
360		73431		
400		73432		
500		73433		
600		73434		
800		73435		
1000		73436		
1200		73437		
1500	73438			
2000	73439			
200 mm	40	15	73633	50
	60		73634	
	80		73635	
	100		73636	100
	120		73637	
	150		73638	
	180		73639	
	220		73958	
	240		73959	
	280		73735	
	320		73778	
	360		73779	

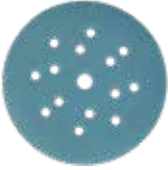

## DG922 COATED ABRASIVE DISCS & SHEETS ALUMINUM OXIDE FILM BACKING

Diameter/Size	Grit	Holes	P/N	Qty/Box
 200 mm	400	15	73838	100
	500		73839	
	600		73832	
	800		73957	
	1000		73834	
	1200		73835	
	1500		73836	
	2000		73837	
 80 x 400 mm	40	14	22396	100
	60		22397	
	80		22398	
	120		22399	
	180		22457	
	240		22453	
	320		22454	
 115 x 400 mm	40	14	73048	100
	60		22455	
	80		73035	
	120		73213	
	180		73036	
	240		73840	
	320		22456	
81 x 133 mm	800	0	24509	100
	1200		73945	
	P150	8	73943	
	P500		73942	



## DG922 COATED DAISY DISCS ALUMINUM OXIDE FILM BACKING



Size	Grit	Holes	P/N	Qty/Box
42 mm	60	0	73316	500
	80		22569	
	120		73916	
	150		73317	
	220		73418	
	240		73917	
	320		73318	
	400		73319	
	600		24610	
	800		73416	
	1200		22570	
	1500		22571	
	2000		73214	



## DG922 COATED ABRASIVE ROLLS ALUMINUM OXIDE FILM BACKING



Size	Grit	P/N	Qty/Box
115 mm x 25 m	40	73041	1
	80	73040	
	120	73014	
	180	73034	
	240	73396	



## CLOG FREE SOFT FILM DISCS POLYESTER BACKING

### APPLICATIONS

- ▶ Surface sanding on any type of wood, metal, composite, solid surface, filler, e-coat, primer, paint coat, clear coat and gel coat.

### FEATURES

- ▶ Very soft and conformable polyester abrasive discs and sheets.
- ▶ Very efficient anticlog treatment.
- ▶ Hook-Face Attachment.
- ▶ Available in grits from P280 to P3000.

### BENEFITS

- ▶ Allows to achieve very fine and even surfaces, ideal preparation to polishing.
- ▶ Excellent on coatings, paints, clearcoats, laquers,...

### TARGET MARKETS

- ▶ Metal Fabrication, Casting and Forging, Woodworking, AOEM, AAM, Marine, Composites.

INFORMATION



Diameter/Size	Grit	Holes	P/N	Qty/Box
75 mm	600	0	22473	50
	800		22479	
	1200		24659	
	1500		24660	
	2000		24661	
	2500		24662	
	3000		24663	
125 mm	280	0	24519	25
	320		24520	
	400		24521	
	600		24522	
	800		22363	
	1200		24523	
	1500		24524	
	2000		24525	
	2500		24526	
	3000		24527	
125 mm	320	7	24528	25
	400		24529	
	600		24531	
	1200		24532	
	2000		24533	
	3000	24534		

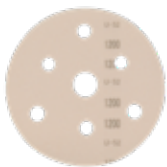

EXAMPLE WITH : 59109







EXAMPLE WITH : X51H + 59039



EXAMPLE WITH : 52760

**CLOG FREE SOFT FILM DISCS & SHEETS**

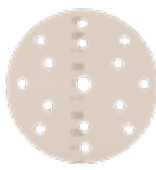
POLYESTER BACKING WITH HOOK-FACE ATTACHEMENT | 13,000 RPM MOS | ALUMINUM OXIDE

Diameter/Size	Grit	Holes	P/N	Qty/Box
 125 mm	400	9	24530	25
	500		22492	
	600		24670	
	800		22364	
	1500		24671	
	2000		22482	
	2500		22483	
 150 mm	3000	0	24672	25
	280		24535	
	320		24536	
	400		24537	
	600		24538	
	800		22365	
	1200		24539	
 150 mm	1500	15	24542	25
	2000		24543	
	2500		24544	
	3000		24545	
	400		24548	
	600		24673	
	800		24674	
 150 mm	1200	7	24550	25
	1500		24675	
	2000		24676	
	2500		24677	
 170 x 130 mm	3000	0	24678	25
	600		24549	
	800		24551	
	1200		24552	
	1500		24553	
	2000		24554	
	2500		22484	
3000	24679			
	1200		24559	
	1500		24560	
	2000		24561	
	2500		24562	
	3000		24563	



EXAMPLE WITH : X51V



## DG997 CERAMIC FILM DISCS & JUMBO ROLLS HOOK-FACE BACKING

### APPLICATIONS

- ▶ Stock removal and intermediate finish on wood, metals, composites, primers, solid surface.

### FEATURES

- ▶ Ceramic grain.
- ▶ Hook-Face Attachment
- ▶ Film backing.
- ▶ Anticlog treatment.

### BENEFITS

- ▶ Heavy stock removal and long life.
- ▶ Superior mechanical resistance and even finish.
- ▶ No wild scratches.

### TARGET MARKETS

- ▶ Metal Fabrication, Casting and Forging, Woodworking, AOEM, AAM, Marine, Composites.

INFORMATION

### JUMBO ROLLS

Diameter	Grit	Holes	Qty/Box
50 mm x 25 m	120	73167	1
	150	73168	
	180	73169	
1400 mm x 100 m	40	73975	
	60	73976	
	80	73977	
	120	73978	
	150	73979	
	180	73980	
	240	73981	
	320	73982	
	400	73983	
600	73984		

### CERAMIC FILMS DISCS

Diameter	Grit	Holes	P/N	Qty/Box
125 mm	80	0	73172	100
	120		73173	
150 mm	P40	15	73155	100
	P60		73156	
	P80		73157	
	P120		73158	
	P150		73159	
	P180		73160	
	P240		73161	
	P320		73162	
	P400		73163	
	P600		73164	
150 mm	P40	0	73965	100
	P60		739696	
	P80		73967	
	P120		73968	
	P150		73970	
	P180		73971	
	P240		73972	
	P320		73973	
	P400		73974	
	P600		73975	



# DYNORBITAL® EXTREME

Dynabrade proudly introduces our most refined random orbital sander to date. The Dynorbital® Extreme boasts the greatest power and most consistent speed of any palm-style orbital sander. Power and speed combine to quickly and reliably produce the desired finish, while ergonomic features keep operators safe and comfortable throughout their day. Symmetrical design allows left or right-handed operators to work comfortably, while the compact size of the Dynorbital® Extreme fits naturally in most operator's hands.



### 3/16" (5 mm) Dia Orbit

General sanding.  
Teal throttle lever for easy identification.



### 3/32" (2,5 mm) Dia Orbit

Ultra-fine sanding.  
Black throttle lever for easy identification.



## DYNAMESH DISCS

Dynamesh Abrasives have a mesh structure and are clog resistant and are long lasting.

### APPLICATION

- ▶ Intermediate to fine application on clogging materials.

### FEATURES

- ▶ Mesh structure.
- ▶ Hook-Face Attachment

### BENEFITS

- ▶ Clog resistant.
- ▶ Excellent dust extraction.

### TARGET MARKETS

## INFORMATION

Diameter	Grit	Holes	P/N	Qty/Box	Type
75 mm	P120	0	71420	50	Disc
	P180		71421		
125 mm	P80	0	23060	50	Disc
	P100		23061		
	P120		23062		
	P150		23063		
	P180		23064		
	P220		23065		
	P240		23066		
	P280		23071		
	P320		23067		
	P400		23068		
	P500		23069		
	P600		23070		
150 mm	P80	0	22780	50	Disc
	P100		22781		
	P120		22782		
	P150		22783		
	P180		22784		
	P220		22785		
	P240		22786		
	P320		22787		
	P400		22788		
	P500		22789		
P600	22790				
225 mm	P120	0	22793	50	Disc



EXAMPLE WITH : X61

## DYNAMESH JUMBO ROLL



Diameter	Grit	P/N	Qty/Box
90 mm x 10 m	80	22795	1
	120	22797	
115 mm x 10 m	80	22791	
	120	22792	
1380 mm x 50 m	80	23049	
	100	23050	
	120	23051	
	150	23052	
	180	23053	
	220	23054	
	240	23055	
	320	23056	
	400	23057	
	500	23058	
600	23059		



## DM555 SOFT SANDING DISCS SILICON CARBIDE - FOAM BACKING

### APPLICATIONS

- ▶ Finishing of paints, lacquers, solid surface.

### FEATURES

- ▶ Hook Face Attachment.
- ▶ Fine sanding of lacquers before polishing.
- ▶ Packed in an exclusive Dynabrade premium metal box for dust free storage.

### BENEFITS

- ▶ Soft foam backing allows flexible sanding of both smooth and profiled surfaces.
- ▶ Reconditioning of conventional clear coats before polishing application.
- ▶ Soft foam backing avoids damaging of contours.

### TARGET MARKETS

- ▶ AOEM, AAM, Solid Surfaces, Tier 1.

INFORMATION



Diameter	Grit	Holes	P/N	Qty/Box
80 mm	800	0	72925	20
	1000		72926	
	1500		72927	
	2000		72928	
	3000		72929	
150 mm	800	0	72935	10
	1000		72936	
	1500		72937	
	2000		72938	
	3000		72939	



# LOCKING-TYPE COATED DISCS

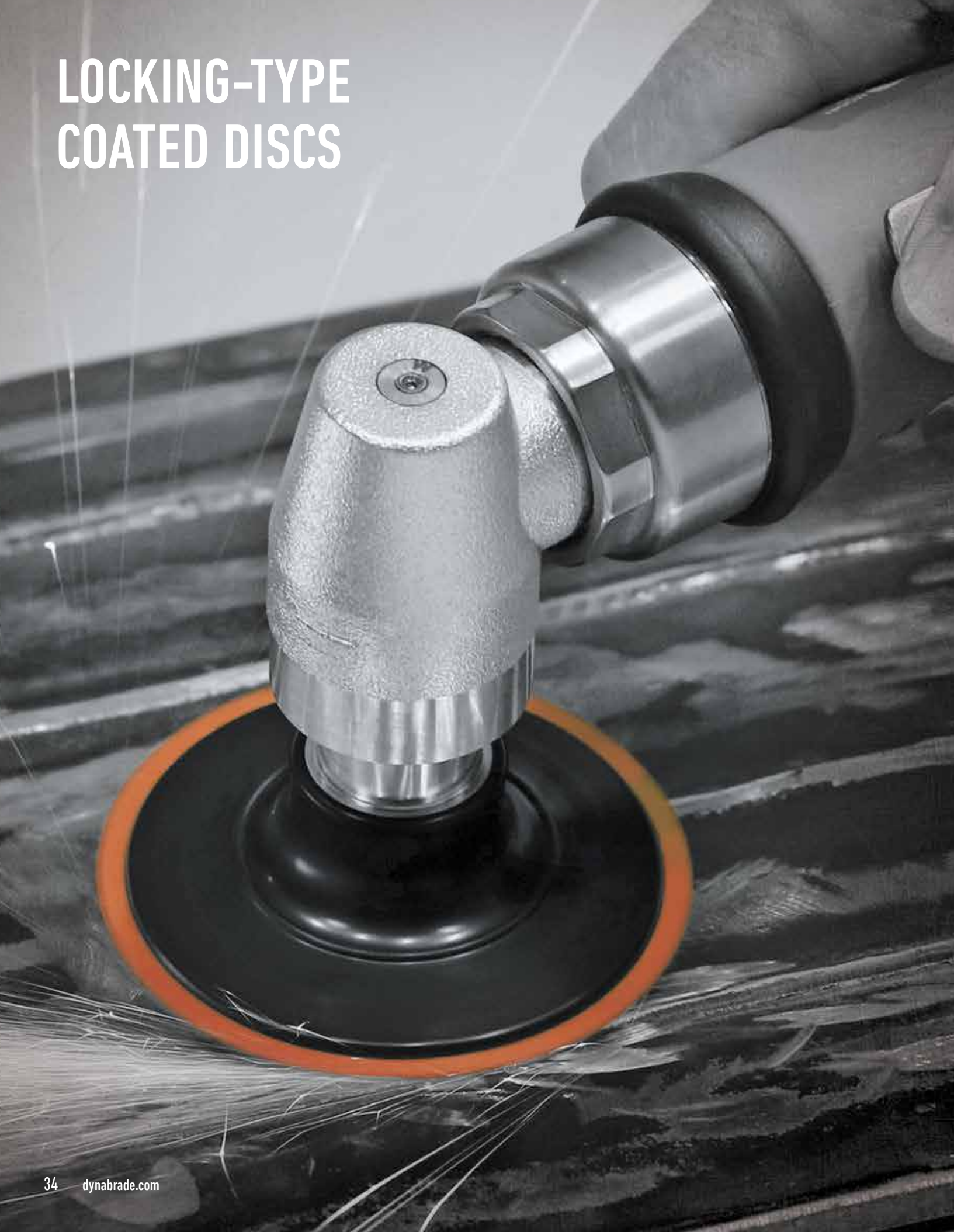

## LOCKING-TYPE COATED DISCS

Locking-type discs provide tool-free fastening with a "twist on, twist off" feature that makes changing small diameter discs fast and efficient to maximize productivity and reduce downtime. Used with right angle mini-grinders Dynabrade DC 321 & Dynafire

Locking-type discs are ideal for weld grinding and blending, from heavy metal removal to light deburring and finishing on flat and contoured surfaces. Available in 50mm 75mm & 100mm diameters with grit sizes from 36 through 120 grits

## DC321 LOCKING-TYPE FIBER DISCS ZIRCONIA ALUMINIA

### APPLICATIONS

- ▶ Removal of thick weld seams, deburring, preparation for welding on thick steel, stainless steel and titanium workpieces.

### FEATURES AND BENEFITS

- ▶ Competitively priced heavy duty fiber disc with high grade Aluminum Zirconia mineral with a special chemical which helps to efficiently reduce heating in grinding applications.
- ▶ Ideal for heavy stock removal to finishing on stainless steel, carbon steel, titanium, exotic alloys, bronze for price sensitive customers.

### TARGET MARKETS

- ▶ Stainless Steel and Heavy Metal Fabrication, Heavy Industries, Foundries.

INFORMATION



Diameter	Grit	Attachment	MOS	P/N	Qty/Box
50 mm	36	Locking-Type	30,000 RPM	73686	100
	60			73687	
	80			73688	
	120			73689	
75 mm	36		73589		
	60		73590		
	80		73591		
	120		73592		
100 mm	36		73671		
	60		73672		
	80		73673		
	120		73674		



EXAMPLE WITH : 47821



EXAMPLE WITH : 50320

## DYNAFIRE LOCKING-TYPE FIBER DISC CERAMIC FIBER DISCS WITH GRINDING AID

### APPLICATIONS

- ▶ Removal of thick weld seams, deburring, preparation for welding on thick steel, stainless steel and titanium workpieces.

### FEATURES AND BENEFITS

- ▶ Heavy duty fiber disc with new generation of ceramic aluminum oxide mineral with a special chemical which helps very efficiently to reduce heating in grinding applications.
- ▶ Ideal for heavy stock removal to finishing on stainless steel, carbon steel, titanium, exotic alloys and bronze.

### TARGET MARKETS

- ▶ Stainless Steel and Heavy Metal Fabrication, Heavy Industries, Foundries.

INFORMATION



Diameter	Grit	Attachment	MOS	P/N	Qty/Box	
50 mm	36	Locking-Type	30,000 RPM	73800	100	
	60			73801		
	80			73802		
	120			73803		
75 mm	36		73804	20,000 RPM		73805
	60		73806			
	80		73807			
	120		73675			
100 mm	36		73676	15,000 RPM		73677
	60		73678			
	80					
	120					



EXAMPLE : 52657



Heavy stock removal applications generally require aggressive abrasive discs and tools that deliver torque under load. Dynabrade manufactures right angle geared tools for these types of applications. Geared tools tend to run more slowly than gearless tools but maintain rotation when heavy

1.3 HP DISC SANDER



48520



54400



52635



Blending applications typically require finer grit abrasive discs and tools that can finish quickly and efficiently. Dynabrade manufactures gearless disc sanders for these applications. Gearless tools generally operate at higher speeds, are more quiet and have fewer parts to maintain when



48503



52412



50320



APPLICATION GRIT GUIDE

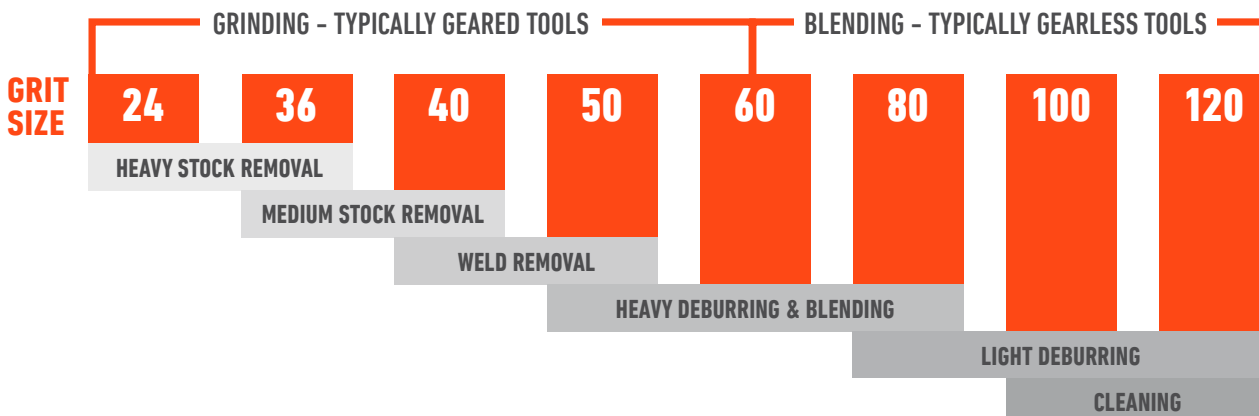



# COATED FLAP DISCS





## COATED LOCKING-TYPE FLAP DISCS

Flap Discs are one of the most versatile grinding and finishing abrasives for applications ranging from heavy stock removal to surface blending and finishing. Flap discs have three components – a backing plate, adhesive and coated abrasive cloth flaps. Small coated abrasive rectangles are concentrically placed on the backing and glued in place, overlapping each other to form a layered abrasive disc.

Designed for use on right angle grinders, flap discs

can grind, blend and finish in one operation which can often replace the traditional two-step process of grinding with a type 27 grinding wheel then finishing with a resin fiber disc. Flap discs by their design, are easier to control, are cooler cutting and offer faster removal with more consistent finishes versus type 27 grinding wheels that vibrate more, are louder and contribute to operator fatigue.

Compared to fiber discs, flap discs can last up to 20 times longer or more and have a self-sharpening

action from the multi-layered flaps. Additional benefits of flap discs are that they do not require a back-up pad and are not impacted by humidity making them easier to store and more reliable to use.

Flap disc applications include grinding, stock removal, edge chamfering, weld blending, deburring, rust removal and cleaning, finishing and polishing to mirror finish. Grit range is 40, 60, 80 and 120

## LOCKING-TYPE FLAP DISC ZIRCONIA ALUMINIA

### APPLICATIONS

- ▶ The best choice when grinding and finishing a wide variety of materials like mild carbon steel and stainless steel, aluminum, fiberglass and plastics.

### FEATURES

- ▶ Premium, self-sharpening zirconia alumina abrasive.
- ▶ High strength backing provides mechanical resistance for tough applications.
- ▶ 50 mm and 75mm quick change mini flap discs with TR attachment.

### BENEFITS

- ▶ Generates an aggressive and rapid cut rate and up to 30% longer life than competitive flap discs.
- ▶ Excellent grain adhesion, edge fray resistance and absorbs vibration.

### TARGET MARKETS

- ▶ Stainless Steel and Heavy Metal Fabrication, Heavy Industries, Foundries.

INFORMATION



Diameter	Grit	Shape	MOS	P/N	Qty/Box	
50 mm	40	TR	30,000 RPM	90970	10	
	60			90971		
	80			90972		
	120			90973		
75 mm	40		90924	20,000 RPM		90925
	60		90926			
	80		90927			
	120					



EXAMPLE WITH : 48500

# COATED FIBER DISCS



## COATED FIBER DISCS

The most heavy-duty of coated abrasive discs, Fiber Discs are designed for a variety of applications ranging from heavy stock removal to surface blending and finishing. They are used with rubber or high-strength plastic back-up pads on

pneumatic or electric portable angle grinders. Common applications include stock removal, edge chamfering, weld blending, deburring, rust removal, cleaning and finishing of stainless steel and high nickel alloys, mild carbon steel, ferrous and

nonferrous metals.

Fiber discs are available in 75 mm, 115 mm, 125 mm & 180 mm diameters in the most common grit sizes ranging from 36 grit to 80 grit.

## DV737 CERAMIC DISCS

The PREFERRED choice for stainless steel, titanium and nickel based alloys, mild carbon steel and ferrous metals.

### APPLICATION

- ▶ Weld removal.

### FEATURES AND BENEFITS

- ▶ Ceramic Aluminum oxide with grinding aid cloth, excellent for weld seam removal on any metal. Used on Dynabrade DynaLocke® in rotary motion. Ceramic grain allows fast cut and long life; grinding aid avoids surface heating and discoloration.

### TARGET MARKET

- ▶ Metal fabrication.

INFORMATION



Diameter	Grit	Attachment	MOS	P/N	Qty/Box
75 mm	P120	Hook Face	12,000 RPM	72837	30



EXAMPLE WITH : 69109

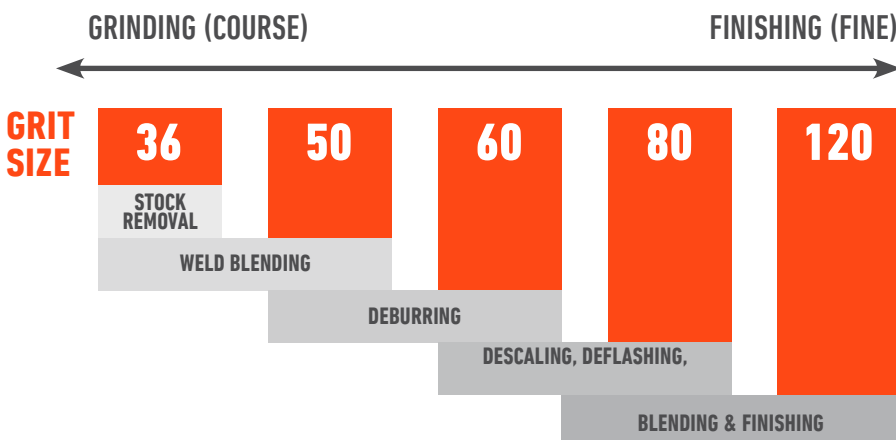

## DYNAFIRE FLANGE MOUNT CERAMIC FIBER DISCS WITH GRINDING AID

The PREFERRED choice for stainless steel, titanium and nickel based alloys, mild carbon steel and ferrous metals.

### APPLICATIONS

- ▶ Removal of thick weld seams, deburring, preparation for welding on thick steel, stainless steel and titanium workpieces.

### FEATURES AND BENEFITS

- ▶ Heavy duty fiber disc with new generation of ceramic aluminum oxide mineral with a special chemical which helps very efficiently to reduce heating in grinding applications.
- ▶ Ideal for heavy stock removal to finishing on stainless steel, carbon steel, titanium, exotic alloys and bronze.

### TARGET MARKETS

- ▶ Stainless Steel and Heavy Metal Fabrication, Heavy Industries, Foundries.

INFORMATION



Diameter	Grit	Attachment	MOS	P/N	Qty/Box
115 mm	36	Flange	12.000 RPM	73780	100
	60			73781	
	80			73782	
	120			73783	
125 mm	36			73784	100
	60			73785	
	80			73786	
	120			73787	
180 mm	36		8.500 RPM	100	73788
	60				73789
	80				73790
	120				73791



EXAMPLE WITH : 53271

## Rebel 2.8 hp Series



**Ultra Gear Grease 96664**  
 - High-performance grease  
 - Purge and re-grease gear case after 1,000 hours of operation

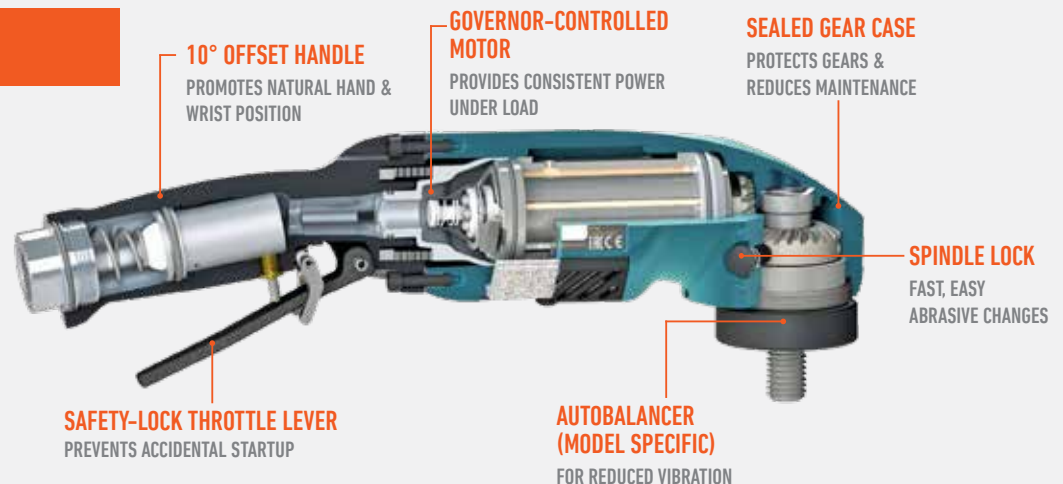

## DQ215 COTTON FIBER DISCS ALUMINUM OXIDE

### APPLICATIONS

- ▶ Weld removal, deburring.

### FEATURES AND BENEFITS

- ▶ Cotton fiber disc structure allows continuous renewal of abrasive grain, consistent cut rate and finish.
- ▶ Excellent for deburring and removal of thin TIG weld seams, giving superior finish with just one pass.

### TARGET MARKETS

- ▶ Metal Fabrication, Mold Production.

INFORMATION

Diameter	Grit	Attachment	MOS	P/N	Qty/Box	Product Name	Type
50 mm	A36 M	Locking Type	25,000 RPM	73066	10	DQ 215 Cotton Fiber Deburring & Finishing Discs	
	A36 XF			73056			
	A54 XF			73057			
	A80 XF			73058			
75 mm	A36 F		20,000 RPM	73059	25		
	A54 F		73060				
	A80 F		73061				
	A36 M		73063				
	A80 M		73064				



EXAMPLE WITH : 48053



Dia x Thickness	Grit	Attachment	MOS (25mm/13mm overhang)	P/N	Qty/Box	Product Name	Type
2.5 mm x 19 mm	MF	3/4" shaft	23/34,000 RPM	24582	10	MP215	Cotton Fiber Mounted Point ST
10 mm x 19 mm	MF	3 mm shaft	34/44,000 RPM	24580			Cotton Fiber Mounted Point Cylindrical
			54/78,000 RPM	24581			
10 mm x 19 mm	MH	3 mm shaft	54/78,000 RPM	73718			Cotton Fiber Mounted Point Ogival
13 mm x 19 mm	FH	3 mm shaft	46/60,000 RPM	73717			



EXAMPLE WITH : 51701

### Spiral Beveled Gears

- Specifically matched to ensure even wear.
- Sealed gear case with high-performance grease for 1,000+ hours of typical usage before recommended maintenance



### Adjustable Muffler

- Directs exhaust away from operator
- Muffler cover can be positioned for left or right-handed operators.



### Multi-Position Guard

- Rotates 67° from center for operator protection and improved sightlines
- 5 screws safely secure guard





# COATED ABRASIVE | SPECIALTIES





COATED ABRASIVE | SPECIALTIES

Dynabrade coated abrasive specialties combined with the wide range of Dynabrade tools provide a broad range of solutions for deburring, sanding,

blending and finishing. A wide variety of shapes, sizes, grits and grains allow Dynabrade abrasives to provide solutions in many markets like woodworking,

metal fabrication, welding, marine, transportation, aerospace, wind energy and more!

SANDING STARS ALUMINIUM OXIDE

Aluminum oxide sanding stars are uniquely designed for consistent performance and versatility. Sanding stars are utilized in wood and metal working applications to sand, deburr and polish. Typically used on contoured, curved, or uneven surfaces sanding stars help prevent undercutting through their flexibility and conformability. Woodworkers can eliminate tedious hand sanding on crown moulding, door panels or finish the inside of wooden bowls while metalworkers often use sanding stars in light deburring applications or for weld spatter removal or even scuffing a surface in preparation for a coating. Available in arbor, spindle and eyelet mount.

APPLICATION

- ▶ Weld removal.
- ▶ Finishing and defuzzing of wood on contoured surfaces and finishing of metals.

FEATURES AND BENEFITS

- ▶ Very flexible aluminum oxide with grinding aid cloth, excellent for weld seam removal on any metal.
- ▶ Excellent life and conformability.

TARGET MARKET

- ▶ Metal & wood fabrication.

INFORMATION

Diameter	Grit	Mineral	MOS	P/N	Qty/Box	Type
19 mm	80	A/O	5000 RPM	93579	1	Eyelet Stars
	120			93580		
	150			93581		
	180			93582		
	220			93583		
25 mm	80	A/O	5000 RPM	93586	1	Eyelet Stars
	120			93587		
	150			93588		
	180			93589		
	220			93590		
38 mm	80	A/O	5000 RPM	93541	1	Eyelet Stars
	120			93542		
	150			93543		
	180			93544		
	220			93545		
	320			93546		
	400			93547		

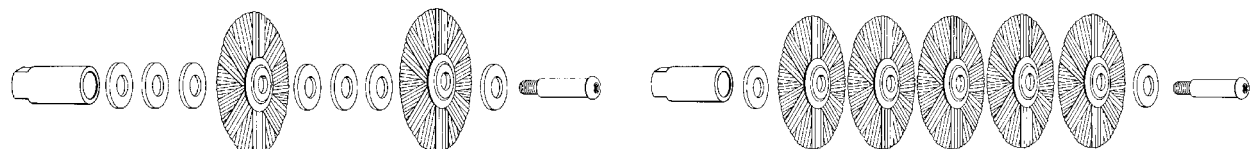

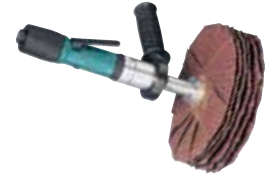

EXAMPLE WITH : 52060

Diameter	Grit	Mineral	MOS	P/N	Qty/Box	Type		
50 mm	80	A/O	5000 RPM	93551	1	Eyelet Stars		
	120			93552				
	150			93553				
	180			93554				
	220			93555				
	320			93556				
	400			93557				
	80			93551				
	120			93552				
	150			93553				
	180			93554				
	220			93555				
	320			93556				
	400			93557				
75 mm	80	A/O	5000 RPM	93558	1	Eyelet Stars		
	120			93559				
	150			93560				
	180			93561				
	220			93562				
	320			93563				
	400			93564				
100 mm	80	A/O	3200 RPM	93565	1	Eyelet Stars		
	120			93566				
	150			93567				
	180			93568				
	220			93569				
	80			3200 RPM			1	Shaft Mounted Stars
	120							
	150		93167					
	180		93168					
	220		93169					
	320		93171					
	400		93172					
	100 mm		80	A/O	5000 RPM	93392	1	Arbor Mount Stars
			120			93393		
150		93394						
180		93395						
220		93396						
320		93397						
400		93398						
200 mm	80	A/O	5000 RPM	93243	1	Arbor Mount Stars		
	120			93245				
	150			93246				
	180			93247				
	220			93248				
	320			93251				
	400			93252				



EXAMPLE WITH : 52050

## CARTRIDGE ROLLS ALUMINUM OXIDE

Size	Grit	MOS	P/N	Qty/Box	Type
13 mm x 178 mm	40	15,500 RPM	22332	5	Cartridge Roll
	60		22333		
	80		22334		
	120		22335		
	180		22359		
19 mm x 178 mm	40	15,500 RPM	22336	5	Cartridge Roll
	60		22337		
	80		22338		
	120		22339		
	180		22358		

Aluminum oxide and cartridge rolls are made from strips of resin-bonded, cloth-backed coated abrasives that are rolled and glued into a solid layered form that breaks down consistently during use. Cartridge rolls are used on Dynapoint II, deburr and finish in small spaces, recesses and corners where larger tools cannot reach.

# NON-WOVEN ABRASIVE BELTS & DISCS

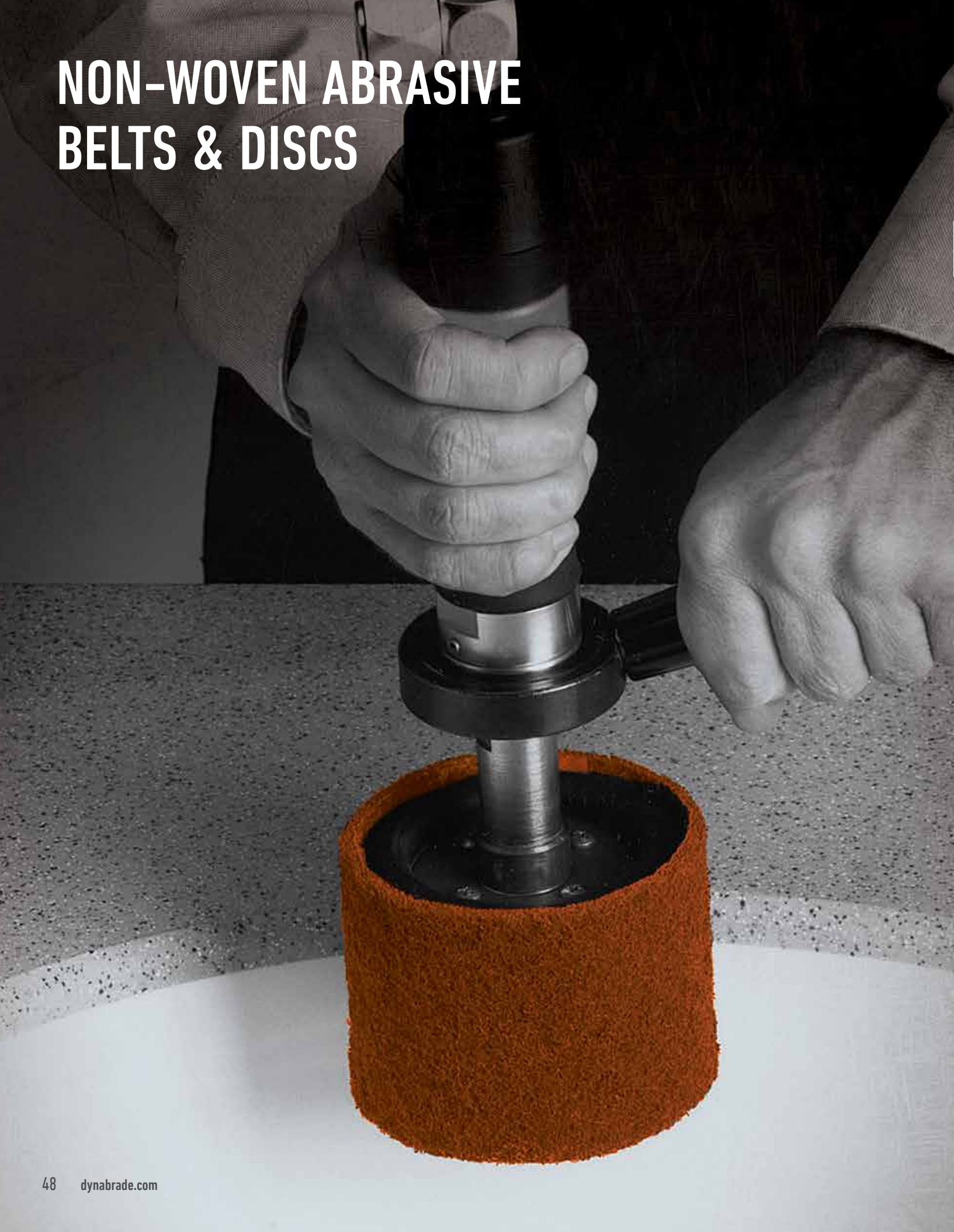

## NON-WOVEN ABRASIVE BELTS

Surface conditioning belts are a combination of a strong, low-stretch, synthetic mesh or woven cloth backing and quality abrasives bonded together by

flexible yet tough adhesives. The open construction of the non-woven surface generates an aggressive cutting action, provides non-loading performance

and generates improved surface finishes. Belts are coated with aluminum oxide in coarse, medium, very fine, and silicon carbide in superfine.

## SURFACE CONDITIONING BELT

	COARSE	MEDIUM	VERY FINE
Scale Removal			
Stock Removal	■		
Heavy Deburring	■		
Light Deburring		■	
Light Finishing		■	
Blending			
Finishing			■

### ABRASIVE GRIT KEY

■	Coarse
■	Medium
■	Very Fine

### APPLICATIONS

- ▶ Satin finish and surface conditioning on metals and alloys.

### FEATURES

- ▶ Low-Stretch Non-Woven Nylon | 27-33 m/s MOS | Aluminum Oxide.
- ▶ Controlled cut does not change the workpiece geometry.

### BENEFITS

- ▶ Burrs and surface oxidations are easily removed.
- ▶ Easily blends the wild scratches from previous working steps.
- ▶ Gives consistent and easily replicable finish on metals and alloys.

### TARGET MARKETS

- ▶ Metal Fabrication, Casting and Forging.

## INFORMATION



Size	Grit	Mineral	P/N	Qty/Box
6 x 305 mm	A CRS		73468	30
	A MED	A/O	73469	
	A VFN		73470	
6 x 457 mm	A CRS		73471	30
	A MED	A/O	73472	
	A VFN		73473	
6 x 610 mm	A CRS		73474	30
	A MED	A/O	73475	
	A VFN		73476	



EXAMPLE WITH : 15013

## SURFACE CONDITIONING BELT

Size	Grit	Mineral	P/N	Qty/Box
6 x 1829 mm	A CRS	A/O	73557	10
	A MED		73558	
	A VFN		73559	
13 x 305 mm	A CRS	A/O	73477	30
	A MED		73478	
	A VFN		73479	
	A VFN		22327	
13 x 330 mm	A CRS	A/O	24618	30
	A MED		24619	
	A VFN		24620	
	S SFN	S/C	24621	
13 x 457 mm	A CRS	A/O	73480	30
	A MED		73481	
	A VFN		73482	
13 x 610 mm	A CRS	A/O	73483	30
	A MED		73484	
	A VFN		73485	
13 x 1829 mm	A CRS	A/O	73560	10
	A MED		73561	
	A VFN		73562	
15 x 457 mm	A MED	A/O	24680	10
	A VFN		24681	
19 x 457 mm	A CRS	A/O	73486	30
	A MED		73487	
	A VFN		73488	
19 x 520 mm	A CRS	A/O	73489	30
	A MED		73490	
	A VFN		73491	
	SSFN		73505	
25 x 457 mm	A CRS	A/O	73492	30
	A MED		73493	
	A VFN		73494	
25 x 610 mm	A MED	A/O	73567	30
	A VFN		73584	
25 x 762 mm	A CRS	A/O	73495	10
	A MED		73496	
	A VFN		73497	
25 x 1829 mm	A CRS	A/O	73563	10
	A MED		73564	
	A VFN		73568	



EXAMPLE WITH : 15003



EXAMPLE WITH : 14000



Size	Grit	Mineral	P/N	Qty/Box
38 x 762 mm	A CRS	A/O	73512	10
	A MED		73514	
	A FN		22357	
38 x 762 mm	A VFN	A/O	73600	10
	A CRS		73604	
	A MED		73700	
	A VF		73701	
	A SF	S/C	73702	
	A SSF	73603		
	A CRS	73498		
50 x 762 mm	A MED	A/O	73499	10
	A VFN	73550		
50 x 864 mm	A CRS	A/O	73551	10
	A MED		73552	
	A VFN		73553	
50 x 1143 mm	A CRS	A/O	73554	10
	A MED		73555	
	A VFN		73556	
50 x 1220 mm	A CRS	A/O	22284	10
	A MED		22285	
	A FIN		22286	
	A VFN		22287	
70 x 394 mm	A MED	A/O	73565	30
	A VFN		73566	
75 x 272 mm	A CRS	A/O	73575	30
	A MED		73576	
	A VFN		73577	
75 x 610 mm	A CRS	A/O	73569	10
	A MED		73570	
	A VFN		73571	
89 x 394 mm	A CRS	A/O	73572	10
	A MED		73573	
	A VFN		73574	
100 x 289 mm	A CRS	A/O	73578	10
	A MED		73579	
	A VFN		73580	

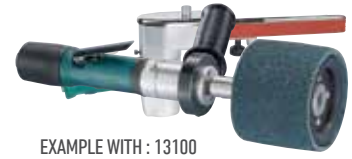

EXAMPLE WITH : 13100



EXAMPLE WITH : 13450



## DYNABRADE BELT TOOL VERSATILITY



40353 Dynaflex® II (.4 hp) is designed for exclusive use with non-woven nylon belts. This tool is excellent for setting grain lines, achieving consistent satin finishes, and removing oxide or weld discoloration. Shown with optional 11204 Contact Arm, with offset design ideal for slack polishing.



## NON-WOVEN ABRASIVE DISCS

Non-Woven abrasive discs provide light grinding, blending and finishing solutions on a wide range of applications. The Dynabrade non woven disc line includes Surface Conditioning Discs DC 323, Unitized discs DU312 + Mandrel & DU368 and Oxide Removal

Discs DB357 + DU379.

Dynaprep discs are an excellent choice for cleaning and surface preparation prior to applying coatings, for cleaning welds, blending mismatch on machined

parts and light deburring of ferrous and nonferrous metals. Additionally, the discs excel at creating decorative finishes and in polishing applications where part conformability is required.

## SURFACE CONDITIONING DISCS - DS323R

	A-COARSE	A-MEDIUM	A-VERY FINE	S-SUPER FINE
Scale Removal				
Stock Removal	■			
Heavy Deburring	■			
Light Deburring		■		
Light Finishing		■		
Blending				
Finishing			■	■

### ABRASIVE GRIT KEY

■	A-COARSE
■	MA-MEDIUM
■	A-VERY FINE
■	S-SUPER FINE

### APPLICATIONS

- ▶ Surface blending on car body panels for optimized processing, grinding down and smoothing welds.
- ▶ Decorative finishing, wood sanding, deburring, cleaning, oxide removal.
- ▶ Removing light edge burrs and other irregularities on the surface.
- ▶ For use on stainless steel, aluminum, titanium, alloys, fiberglass and plastic.

### FEATURES

- ▶ Non-woven web structure for less clogging and better lifetime than ordinary coated abrasive discs.
- ▶ High content of aluminum oxide.

### BENEFITS

- ▶ Disc can be easily changed with one turn of the locking-type system.
- ▶ Greater resistance to loading due to the open structure of the discs compared to standard surface conditioning discs.
- ▶ No slipping with the locking-type system and always central run. Less downtime for changes.

### TARGET MARKETS

- ▶ Removing surface defects on Plastic Products, Stainless Steel Furniture, Machinery for the Chemical and Food Industries, General production in the Automotive, Railway, Marine and Aerospace Industries.

INFORMATION



Diameter	Grit	Attachment	P/N	Product Name	Qty/Box
50 mm	A-Coarse	Locking-Type	72953	DS 323R	50
	A-Medium		72954		
	A-Very Fine		72955		
	S-Super Fine		22616		
75 mm	A-Coarse	Locking-Type	72956	DS 323R	25
	A-Medium		72957		
	A-Very Fine		72958		
	S-Super Fine		22617		
100 mm	A-Coarse	Locking-Type	72959	DS 323R	25
	A-Medium		72960		
	A-Very Fine		72961		
115 mm	A-Coarse	Hook Face	72950	DS 323V	10
	A-Medium		72951		
	Very Fine		72952		
150 mm	A-Coarse	Hook Face	22341	DS 323V	10
	A-Medium		22342		
	A-Very Fine		22360		



EXAMPLE : 47821



EXAMPLE : 48530



EXAMPLE : 54430

## SURFACE CONDITIONING DISCS – SC-DR

Diameter	Grit	Attachment	P/N	Product Name	Qty/Box
50 mm	A MED	Locking-Type	71392	SC-DR	200
	A CRS		71393		
75 mm	A CRS		71390		
	A MED		71391		

## UNITIZED ABRASIVE DISCS – DU312F OR DU368

DU312F high-strength arbor hole discs features a non-woven abrasive web that is firm and durable, yet tough and conformable. Using high-performance abrasives and smear-resistant resin bond, unitized Discs combats tearing on burrs and sharp edges. Whether used alone or ganged together to form a wheel DU312F unitized discs are an ideal choice for removal of

rust, oxides or coatings, polishing pipe OD and ID, cleaning castings, gasket removal, blending out surface imperfections and handling marks, surface preparation for soldering, cleaning angles and odd shapes without changing part profiles. DU312F & DU368 unitized discs are a 3 dimensional abrasive made from highly compressed layers of non-woven web, saturated with specialized smear

resistant resin and premium abrasives. Unitized discs can generate moderate to light stock removal and achieve excellent finishes using their edges and face to deburr, blend and polish a wide range of surfaces and surface shapes on nonferrous and ferrous metals, exotic metals and alloys, composites and glass.

## UNITIZED DISCS – DU312F

	A-COARSE	A-MEDIUM	S-FINE
Scale Removal			
Stock Removal			
Heavy Deburring			
Light Deburring			
Light Finishing			
Blending			
Finishing			

### ABRASIVE GRIT KEY

- A-COARSE
- A-MEDIUM
- S-FINE

### APPLICATIONS

- ▶ Deburring, blending and finishing on stainless steel, carbon steel, titanium, exotic alloys.
- ▶ Removing of discoloration after the welding operation.

### FEATURES

- ▶ SiC or Alox/Fiber Backing.
- ▶ 22 mm Center Hole.

### BENEFITS

- ▶ Excellent for deburring, round sharp edges and removing oxides from metal surfaces.
- ▶ Use of the fine grits allows removal of oxides from weld seams without using any chemicals. Also excellent for surface preparation to mirror polishing.

### TARGET MARKETS

- ▶ Metal Fabrication, Molds Production.

INFORMATION

## UNITIZED ABRASIVES – SILICON CARBIDE OR ALUMINUM OXIDE/FIBRE BACKING – DU312F

S: Silicon Carbide & A: Aluminum Oxide - Density 2: Soft/Flexible & 8: Hard/Stiff.



Diameter	Density & Grit	Attachment	P/N	MOS	Qty/Box
115 mm	2 SFIN	22 mm Hole	72985	11,000 RPM	10
	3 SFIN		72986		
	2 AMED		72987		
	6 AMED		72988		
	8 ACRS		72989		



## UNITIZED ABRASIVES – SILICON CARBIDE OR ALUMINUM OXIDE/FIBRE BACKING – DU368R

### APPLICATIONS

- ▶ Deburring, blending and finishing on stainless steel, carbon steel, titanium, exotic alloys.
- ▶ Removing of discoloration after the welding operation.

### FEATURES

- ▶ SiC or Alox NWN Wheels and Discs.
- ▶ Exists in center Hole or Locking-Type attachment.
- ▶ Compressed non-woven layers in aluminum oxide for general purpose or in silicon carbide for delicate application.

### BENEFITS

- ▶ Controlled cut, cool running, low loading.
- ▶ Flexible structure of the material reduces the risk of damage to the work piece.
- ▶ Compressed layers of non-woven material for consistent and uniform finish with extended lifespan.
- ▶ Excellent alternative to set-up wheels, greaseless compounds, and steel wool.
- ▶ Efficient removal with optical bright finishing.

### TARGET MARKETS

- ▶ Metal Fabrication, AOEM, Maintenance.

INFORMATION



Diameter	Density & Grit	Attachment	P/N	MOS	Qty/Box
50 mm	2 SFIN	Locking-Type	24599	15,000 RPM	10
	3 SFIN		22574		
	2 AMED		22573		
75 mm	2 SFIN	Locking-Type	72980		
	3 SFIN		72981		
	2 AMED		72982		
	6 AMED		72983		
	8 ACRS		72984		

## SHAFT MANDREL FOR MOUNTING CENTER HOLE ABRASIVES



Diameter	P/N	Qty/Box
6 mm	72998	5

### OXIDE REMOVAL ABRASIVES

Oxide Removal Discs DB357 – DU379 are made from a slightly compressed, tough, non-woven web that is saturated with specialized resins and extra coarse abrasives. This formulation forms a very open structured disc that will not load on soft metals or when removing sticky coatings.

Additionally, these discs won't snag or shed like a traditional coated abrasive cloth or fiber disc when stripping & cleaning weld beads, burrs from edges, heavy scale and rust encased surfaces. Being a 3D structure it can be used on edge as well as its face and is extremely versatile as a removal

and finishing tool that won't gouge or cause rework. Dynabrade Oxide Removal Discs comes in 3 variants Center Hole, Locking-Type or Shaft attachment

### NOTE

- ▶ DB 357 Conforms to work area, ideal for use in automotive paint removal.
- ▶ DO 379 Made of rigid open web that is aggressive and long-lasting.

### APPLICATIONS

- ▶ Ideal for work on stainless steel, standard or alloyed steel, aluminum, titanium, non-ferrous materials and alloys, fiberglass, plastic, stone or wood.
- ▶ Aggressively removes paint and rust from welding seams, undercoating, seam-sealers and stone guards.
- ▶ Applications in trunk beds and door jambs for removing sealant.
- ▶ Used to remove oxidation from tire rims and rust from brake assemblies.
- ▶ Removing weld blueing and oxide on stainless steel containers.
- ▶ Removing of old gasket material on cylinder heads of diesel engines.
- ▶ For cleaning welds and light coating removal.

### FEATURES AND BENEFITS

- ▶ Strong 3-dimensional synthetic fiber construction, very open, with extra-coarse silicon carbide.
- ▶ High resistance to clogging and fast removal. Long lifetime; safer than wire brushes.
- ▶ Conforms to work piece and does not damage the surface.
- ▶ Allows access to difficult areas like wheel wells and under-carriage.
- ▶ Fast removal of rust and paint without base material removal.

### TARGET MARKETS

- ▶ Metal Fabrication, Automotive, Marine, General Industry.



## DB357 OXIDE REMOVAL ABRASIVES - SIC/NWN



Diameter	Thickness	Attachment	P/N	MOS	Product Name	Qty/Box	Type
75 mm	13 mm	13 mm Hole	72962	10,500 RPM	DB 357H	10	Oxide Removal Wheels/Discs - Black
		Locking-Type	72963	7,000 RPM	DB 357R		
		6 mm Shaft	72964	10,500 RPM	DB 357S		
100 mm	13 mm	13 mm Hole	72965	8,000 RPM	DB 357H	10	Oxide Removal Wheels - Black
		6 mm Shaft	72966		DB 357S		
	25 mm	6 mm Shaft	72969		DB 357S		
150 mm	13 mm	13 mm Hole	72967	5,350 RPM	DB 357H	10	Oxide Removal Wheels - Black
		8 mm Shaft	72968		DB 357S		
	25 mm	8 mm Shaft	72970		DB 357S		

## DO379 OXIDE REMOVAL ABRASIVES - SIC/NWN



Diameter	Thickness	Attachment	P/N	MOS	Product Name	Qty/Box	Type
75 mm	13 mm	13 mm Hole	72971	10,500 RPM	DO 379H	10	Oxide Removal Wheels/Discs - Orange
		Locking-Type	72973	7,000 RPM	DO 379R		
		6 mm Shaft	72972	10,500 RPM	DO 379S		
100 mm	13 mm	13 mm Hole	72974	8,000 RPM	DO 379H	10	Oxide Removal Wheels - Orange
		6 mm Shaft	72975		DO 379S		
	25 mm	6 mm Shaft	72978		DO 379S		
150 mm	13 mm	13 mm Hole	72976	5,350 RPM	DO 379H	10	Oxide Removal Wheels - Orange
		20 mm Hole	72949		DO 379H		
		8 mm Shaft	72977		DO 379S		
	25 mm	8 mm Shaft	72979		DO 379S		

**OXIDE REMOVAL WHEELS**

DB-FB & DP-FB Wheels are ideal for a wide range of deburring and finishing applications.

Wheels used on stainless steel, aluminum, titanium, carbon steel, plastic, composites, alloys and more!

**DB-FB PLASTIC CORE FLAP BRUSHES - FLAP BRUSHES FOR SATIN FINISHING**



Size	Grit	Bore	P/N	MOS	Qty/Box
105 mm x 100 mm	A CRS	19 mm	72821	3,400 RPM	1
	A MED		72948		
	A FIN		73049		
	A VFN		73140		
	S MED		73216		
	S FIN		73217		
	S VFN		73218		
	S SFN		72941		
	S UFN600		72942		
	SSFN 1000		73240		

**DP-FB PLASTIC CORE FLAP BRUSHES IN C&P RAW MATERIAL - FLAP BRUSHES FOR SATIN FINISHING**

Suitable for Heavy Applications on stainless steel

Size	Grit	Bore	P/N	MOS	Qty/Box
105 mm x 100 mm	A MED Cut&Polish	19 mm	73297	3,400 RPM	1

## DYNISHER & MINI-DYNISHER – FINISHING TOOLS

Dynisher finishing tools are ideally suited for setting a grain pattern once a weld has been removed. When combined with a Dynacushion® pneumatic tire operators will experience a tool that conforms to the work surface yet still has the power to drive an aggressive coated abrasive. When equipped with optional Dynabrite Interleaf wheels operators can achieve fine finishes quickly.



# STRUCTURED ABRASIVES



# STRUCTURED ABRASIVES CLOTH BACKED – DISCS & JUMBO ROLLS – ALUMINUM OXIDE

## APPLICATIONS

- ▶ Intermediate to final finish on stainless steel, Metals and Aluminum.

## FEATURES

- ▶ Structured abrasive.
- ▶ Wide product range.

## BENEFITS

- ▶ Long life.
- ▶ Consistent finish.
- ▶ Suitable for intermediate to fine finish.

## TARGET MARKETS

- ▶ Metal Fabrication, AAM, AOEM, Marine, Aerospace, Wood, Carbon fibers.

INFORMATION



Diameter	Grit*	Backing*	P/N	Qty/Box
115 mm	A6	H* / Laminated - Hook-Face	22685	25
	A16		22684	
	A30		22683	
	A45		22687	
	A6	S* / Laminated - Hook-Face	22682	
	A16		22681	
	A30		22680	
	A45		22686	
127 mm	A6	H* / Laminated - Hook-Face	22679	25
	A16		22678	
	A30		22677	
	A45		22689	
	A6	S* / Laminated - Hook-Face	22676	
	A16		22675	
	A30		22674	
	A45		22688	

Diameter	Grit*	Backing*	P/N	Qty/Box
500 mm x 50 m	A6	H* / Dry - Without Hook-Face	22906	1
	A16		22905	
	A30		22904	
	A45		22903	
	A65		22892	
	A80		22893	
	A6	S* / Dry - Without Hook-Face	22899	1
	A16		22898	
	A30		22897	
	A65		22896	
	A45		22894	
	A6	H* / Laminated - Hook-Face	22914	1
	A16		22913	
	A30		22912	
	A45		22911	
A65	22915			



BACKING\* : H = HEAVY / S = SOFT  
S = J-WEIGHT RAYON FLEXIBLE BACKING;  
H = X-WEIGHT COTTON BACKING.

## DYNASAF – DISCS & JUMBO ROLLS

Very fine grits structured abrasives for finishing applications with foam backing hook face.

### APPLICATIONS

- ▶ Final finish and preparation to polishing in AOEM, AAM, Aerospace, Marine, Woodworking.

### FEATURES

- ▶ Soft structure.
- ▶ Precise abrasive coating.
- ▶ Very fine grits.

### BENEFITS

- ▶ Conformable, suitable for contoured surfaces.
- ▶ Even and consistent finish.
- ▶ Easy to buff.

### TARGET MARKETS

- ▶ AAM, AOEM, Marine, Aerospace, Wood, Solid surface.

INFORMATION



Diameter	Grit	Backing	P/N	Qty/Box
75 mm	P3000	Brush Nylon	22843	15
150 mm	P3000		22842	
75 mm	P5000		22885	
150 mm	P5000		22884	



Size	Grit	Backing	P/N
500 mm x 50 m	P1000	Without Velcro	22900
	P3000	Velcro	22882
	P3000	Without Velcro	22901
	P5000	Velcro	22895
	P5000	Without Velcro	22902



## DYNASAF 379 YB – DISCS & JUMBO ROLLS

Film backed structured abrasives for intermediate to finishing applications.

### APPLICATIONS

- ▶ Final finish and mirror polishing on stainless steel, metals, solid surface, glass.

### FEATURES AND BENEFITS

- ▶ Structured abrasive.
- ▶ Film backing.
- ▶ Long life, consistent finish and superior mechanical resistance.

### TARGET MARKETS

- ▶ Metalfabrication, solid surface.

INFORMATION

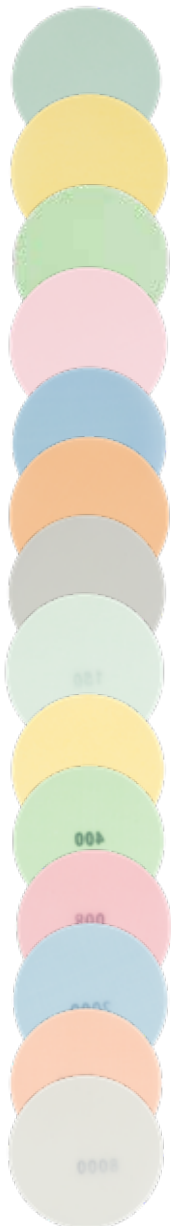

Diameter/Size	Grit	Backing	P/N	Qty/Box	Type
115 mm	80	Brush Nylon	22740	50	Disc
	60		22741		
	35		22742		
	22		22743		
	9		22744		
	3		22745		
150 mm	1	Brush Nylon	22746	50	Disc
	35		22699		
	22		22713		
	9		22714		
	3		22715		
	1		22717		
180 mm	80	Brush Nylon	22726	50	Disc
	60		22727		
	35		22728		
	22		22729		
	9		22730		
	3		22731		
420 mm	1	Brush Nylon	22732	50	Disc
	80		22733		
	60		22734		
	35		22735		
	22		22736		
	9		22737		
500 mm x 50 m	3	Brush Nylon	22738	50	Jumbo Roll
	1		22739		
	35		22694		
	22		22695		
	9		22696		
	3		22697		
	5 TAO		22716		



# DYNABURR™

## CARBIDE BURRS



# DYNABURR™ CARBIDE BURRS

Carbide rotary burrs are used for cutting, shaping, grinding and for the removal of sharp edges, burrs and excess material.

Tungsten carbide burrs are commonly used on a variety of materials including steel, stainless steel, aluminum, cast iron, exotic alloys, precious metals, ceramics and composites, non-ferrous metals and wood.

The Key markets for DynaBurr Tungsten Carbide Burrs include Transportation – Aerospace, Rail, Marine and Automotive; Metalworking and Metal Fabrication – Welding, Tool and Die, Castings and Foundries; Energy – Oil and Gas, Wind Turbine.



DynaBurr™ tungsten carbide burrs are used on Dynabrade pencil grinders and die grinders. All DynaBurr's are double cut style and are ideal for medium to light stock removal, chamfering, deburring, weld removal and blending, creating radii, precise finishing, polishing and for removal of parting lines and flash. DynaBurr tungsten carbide burrs provide significantly longer life than high speed steel burrs.

Available in 3 mm and 6 mm metric shanks and 1/8" and 1/4" shank sizes.

DynaBurr™ carbide burrs are offered in the most common shapes including:

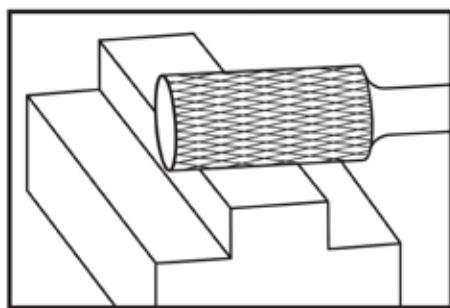

**CYLINDER**

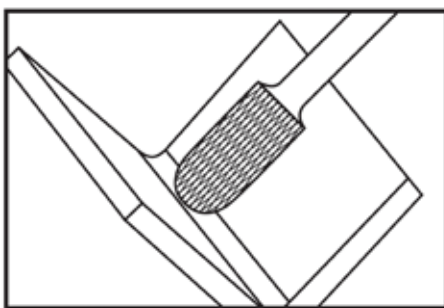

**RADIUSED END CYLINDER**

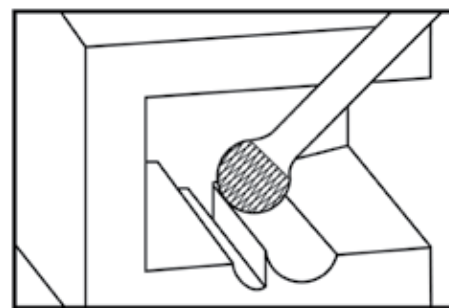

**BALL**

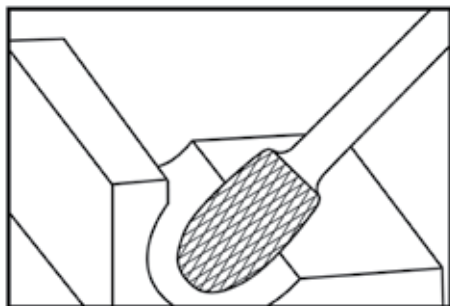

**OVAL**

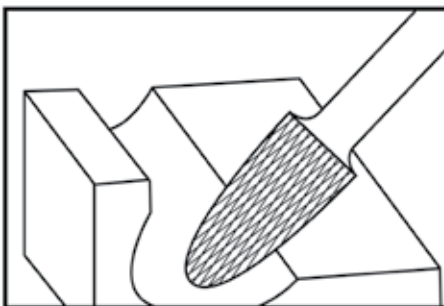

**TREE**

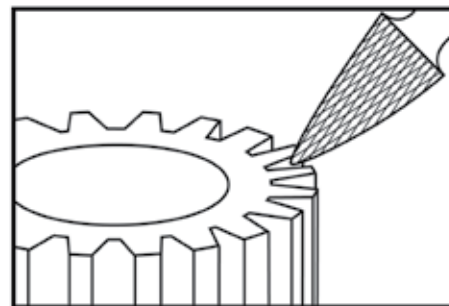

**RADIUSED END TREE**

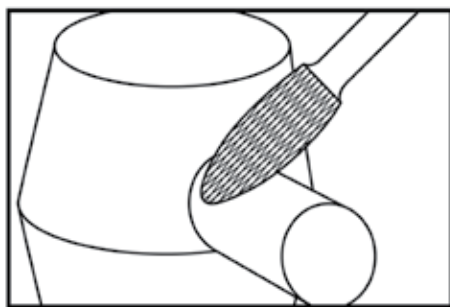

**POINTED END FLAME**

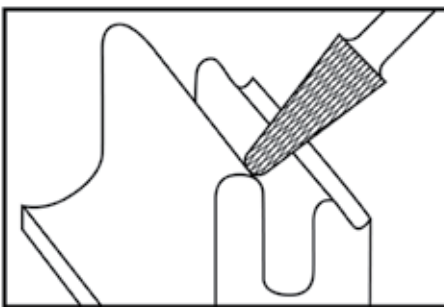

**RADIUSED END TAPER**

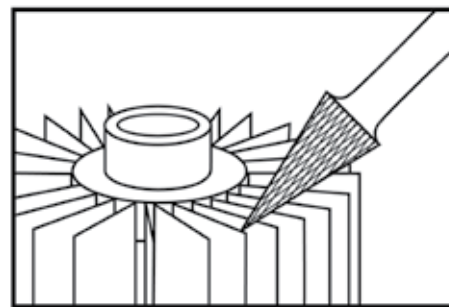

**CONE**

- 1 Apply light pressure and let the burr do the work.
- Keep the carbide burr moving along the surface to avoid gouging and digging causing a rough surface.
- Try to end on an up stroke to generate smoother finishes.
- Ensure burr is inserted into the collet and clamped down tightly.
- Work on the highest material first and use light pressure while keeping the burr moving.
- Make sure the work piece or surface is secure.
- Avoid jamming burr into the work piece.

MATERIALS	RECOMMENDED OPERATING SPEEDS									
Exotic Alloys	1,400-1,800 SFPM 420-540 m/min									
Hardened Steels 45HRc+	1,600-2,200 SFPM 480-660 m/min									
Non-Hardened Steels 45HRc-	2,000-2,600 SFPM 600-780 m/min									
Non-Ferrous Light Metals	2,600-3,000 SFPM 780-900 m/min									
Plastics, Hard Rubber, Fiberglass and Composites	2,400-3,000 SFPM 720-900 m/min									
BURR DIAMETER	RPM									
3-1/2" (2.5 mm)	45,000	53,000	60,000	66,000	73,000	79,000	86,000	92,500	100,000	
1/8" (3 mm)	45,000	53,000	60,000	66,000	73,000	79,000	86,000	92,500	100,000	
1/4" (6 mm)	26,000	30,000	34,000	37,500	41,500	45,000	49,000	52,500	55,000	
3/8" (9 mm)	17,500	20,000	22,500	25,000	27,500	30,000	32,500	35,000	37,500	

- ↳ **COLLET:** Device used to hold carbide burrs, rotary files, mounted points and wheels, etc.
- BODY:** The part of the collet that secures to the spindle of the tool and accepts the inserts.
- CAP:** Secures collet body and retains insert.
- INSERT:** The collapsible portion of the collet that retains the shank of the inserted tool.

**COLLET ASSEMBLY TYPES**











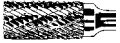
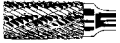

- ↳ **TWO-PIECE:** Insert threads into body.
- THREE-PIECE:** Insert slips into body; cap threads to body, retaining the insert.
- FOUR-PIECE:** Insert slips into body; cap slips over body; nut retains cap and insert.
- INTEGRATED:** Collet body is integrated into tool.



## DYNABURR™ CARBIDE BURRS

DynaBurr™ carbide burrs are used with Dynabrade die grinders for rapid material removal, precise finishing, deburring, and removal of parting lines

and flash. Carbide burrs provide longer life than high-speed steel burrs.

DynaBurr Shape	1/8" & 3 MM DYNABURRS, DOUBLE CUT STYLE					1/4" & 6 MM DYNABURRS, DOUBLE CUT STYLE					
	Part Number	Tool Style	Cutter Diameter	Flute Length	Shaft Size	Part Number	Tool Style	Cutter Diameter	Flute Length	Shaft Size	Package Quantity
 Cylinder	93338	SA-42	3/32"	7/16"	1/8"	93330	SA-1	1/4"	5/8"	1/4"	1
	93368	SA-42	2.5 mm	11 mm	3 mm	93360	SA-1	6 mm	16 mm	6 mm	1
 Cylinder	93339	SA-43	1/8"	9/16"	1/8"	93331	SA-3	3/8"	3/4"	1/4"	1
	93369	SA-43	3 mm	14 mm	3 mm	93361	SA-3	9 mm	19 mm	6 mm	1
 Cylinder	93340	SC-41	3/32"	7/16"	1/8"	n/a	n/a	n/a	n/a	n/a	1
	93370	SC-41	2.5 mm	11 mm	3 mm	n/a	n/a	n/a	n/a	n/a	1
 Cylinder RADIUS End	93341	SC-42	1/8"	9/16"	1/8"	93332	SC-1	1/4"	5/8"	1/4"	1
	93371	SC-42	3 mm	14 mm	3 mm	93362	SC-1	6 mm	16 mm	6 mm	1
 Cylinder RADIUS End	n/a	n/a	n/a	n/a	n/a	93333	SC-3	3/8"	3/4"	1/4"	1
	n/a	n/a	n/a	n/a	n/a	93363	SC-3	9 mm	19 mm	6 mm	1
 Ball	n/a	n/a	n/a	n/a	n/a	93334	SD-3	3/8"	5/16"	1/4"	1
	n/a	n/a	n/a	n/a	n/a	93364	SD-3	9 mm	8 mm	6 mm	1
 Ball RADIUS End	93342	SD-42	1/8"	1/8"	1/8"	n/a	n/a	n/a	n/a	n/a	1
	93372	SD-42	3 mm	3 mm	3 mm	n/a	n/a	n/a	n/a	n/a	1
 Oval	93343	SE-41	1/8"	7/32"	1/8"	93335	SE-3	3/8"	5/8"	1/4"	1
	93373	SE-41	3 mm	5.5 mm	3 mm	93365	SE-3	9 mm	16 mm	6 mm	1
 Tree	93344	SF-42	1/8"	1/2"	1/8"	n/a	n/a	n/a	n/a	n/a	1
	93374	SF-42	3 mm	13 mm	3 mm	n/a	n/a	n/a	n/a	n/a	1
 Tree RADIUS End	93345	SG-44	1/8"	1/2"	1/8"	93336	SF-3	3/8"	3/4"	1/4"	1
	93375	SG-44	3 mm	13 mm	3 mm	93366	SF-3	9 mm	19 mm	6 mm	1
 Flame Pointed End	93346	SH-41	1/8"	1/4"	1/8"	n/a	n/a	n/a	n/a	n/a	1
	93376	SH-41	3 mm	6 mm	3 mm	n/a	n/a	n/a	n/a	n/a	1
 Taper RADIUS End	93347	SL-42	1/8"	1/2"	1/8"	93337	SL-3	3/8"	1-1/16"	1/4"	1
	93377	SL-42	3 mm	13 mm	3 mm	93367	SL-3	9 mm	27 mm	6 mm	1
 14° Cone End	93348	SM-42	1/8"	7/16"	1/8"	n/a	n/a	n/a	n/a	n/a	1
	93378	SM-42	3 mm	11 mm	3 mm	n/a	n/a	n/a	n/a	n/a	1
 10° Inverted Cone	93349	SN-42	1/8"	3/16"	1/8"	n/a	n/a	n/a	n/a	n/a	1
	93379	SN-42	3 mm	5 mm	3 mm	n/a	n/a	n/a	n/a	n/a	1

n/a = Not Available.

## DYNABURR™ KITS

Kits (1/8", 3 mm, 1/4" or 6 mm include one Carbide Burr of each shape, as shown above. Packaged in high-quality case.

Model Number	Burr Shaft Size	Burr Qty
93351	1/8"	12
93380	3 mm	12
93350	1/4"	8
93381	6 mm	8



### DYNACUT INOX STAINLESS STEEL BURR KIT 94020

- 5 Piece, 1/4" shank burr shapes for cutting & grinding of stainless steel



### DYNACUT ALLOY SPECIFIC BURR KIT 94021

- 10 Piece, 1/8" burr shapes for cutting & grinding of nickel and titanium alloys



### DYNACUT ALUMINUM & NON-FERROUS BURR KIT 94022

- 5 Piece, 1/4" shank burr shapes for cutting and grinding aluminum & other non-ferrous materials



# BONDED ABRASIVES





## BONDED ABRASIVES

### FEATURES

- ▶ 100% High-Performance ceramic grain abrasive.
- ▶ High Strength resin and fiberglass reinforcement.

### BENEFITS

- ▶ Excellent cut rate.
- ▶ Fast, cool cutting action provides a longer productive life.
- ▶ 3-5 times the life of conventional aluminum oxide cut-off wheels

### TARGET MARKETS

- ▶ Foundries, metal fabrication.

## CUT-OFF DISCS – ALUMINUM ZIRCONIA



Size	Grit	P/N	Qty/Box
75 mm x 1 mm x 10 mm	46	23368	100
100 mm x 1 mm x 10 mm		24668	25



# POLISHING PRODUCTS



## DYNABRADE FINISHING SYSTEM ABRASIVE TECHNOLOGY

Properly creating a high gloss surface, restoring a worn finish, or correcting defects in coatings, requires sanding to level the clear coat to with the base of the deepest scratch or defect. Using the Dynabrade Finishing System, polishing in one step can be achieved to restore a properly prepared, flat and highly reflective surface. (see Figure A)

Some compounds contain fillers and wax that will fill the defect and appear to generate a high gloss finish, but after a few washes the filler erodes and defects will re-appear. Dynabrade Finishing System compounds contain a unique, high-purity abrasive powder technology with no fillers, waxes, silicone or harmful chemicals. The unique characteristics of the high purity

abrasive allow it to begin polishing coarsely and gradually breakdown to an ultra-fine cut creating a high gloss shine or polish in one step for most colors, on all types of paints. (see Figure B) Without fillers or waxes the Dynabrade Finishing System leaves a completely smooth, flat and highly reflective surface and is easy to wipe away without leaving a residue.

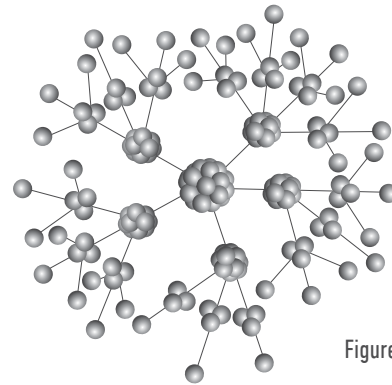
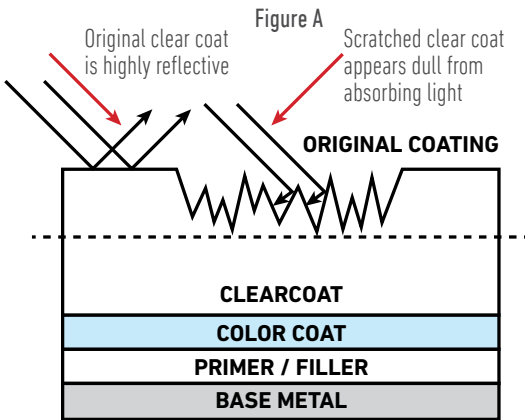

### THE DYNABRADE POLISHING SYSTEM | COMPOUNDS & PADS

The Dynabrade Polishing system is based on high performance compounds that are the result of decades of research and development. Utilizing a unique abrasive powder technology,

the abrasive grain in our high-performance compounds is based on an optimized high-purity, white aluminum oxide powder. The Dynabrade system can remove defects and scratches as well

as polish surfaces in only one step, creating a brilliant mirror-like gloss. Conventional polishing compounds require a minimum of two or more polishing steps to achieve similar results.

## DYNACOARSE - EXTRA COARSE FINISHING

### NOTES

- Dynacoarse ideal for fast removal of deep scratches from grits P800-P1000.

### APPLICATIONS

- Fast removal of deep scratches on gelcoat, paints, plastics. Ideal for application with rotary polishers and wool pads.

### FEATURES AND BENEFITS

- Increase productivity, reduce labor time and costs. Water-based polishing paste, silicone free, enhance final surface finish.
- Avoids swirl and bloom marks as well as holograms when used with our random orbital polishers.

### TARGET MARKETS

- AAM, Marine, Industry (Woodworking, Kitchen and Cabinets, Solid Surface).

Name	Container	Packaging	Color	P/N
Dynacoarse	Bucket	5 Liters	White	22014



INFORMATION

## DYNABLUE - COARSE FINISHING

### APPLICATIONS

► Dynablue is the perfect Polishing Compound to be used on plastics, gel coats and solid surfaces. For best result, use Dynablue with Rotary and Random Orbital Polishers in combination with wool pads for AOEM and Marine applications or Dynabrade foam polishing pads.

### FEATURES AND BENEFITS

- Coarser than Dynared, Dynablue removes scratches left by P1000 -P1200 for good finish on polished surface.
- Water based
- Can be used with wool pads for AOEM and Marine applications.

### TARGET MARKETS

- AAM, AOEM, Marine.

Container	Packaging	Color	P/N
Bottle	1 Liter	Blue	23040
Jug	5 Liters		23041



INFORMATION

## DYNARED - COARSE + FINISH

### APPLICATIONS

► New generation polishing compound in coarse grade. Dynared is ideal for removing scratches from grit P1500-P2000 and finer. More aggressive than Dynacoarse but gives a very good glossy finish (comparable to Dynateal).

### FEATURES AND BENEFITS

- Increase Productivity, Reduce Labor Time and Costs. Silicone Free, Enhance Final High Gloss Surface Finish.
- Avoids swirl and bloom marks as well as holograms when used with our random orbital motion polishers.

### TARGET MARKETS

- AAM, AOEM, Aerospace, Wind Energy, Metal Fabrication, Wood Working, Marine.

Container	Packaging	Color	P/N
Bottle	1 Liter	Red	22017
Jug	5 Liters		22019



INFORMATION

## DYNATEAL - FINE FINISHING

### APPLICATIONS

- ▶ Removes deep scratches on any kind of surface.
- ▶ Polishing compound offers an aggressive cut that can flatten soft orange-peel effect in auto aftermarket.
- ▶ Removes medium defects such as swirl marks, water spots and sanding marks.
- ▶ Can be used to prepare the car body for the subsequent high gloss surface finish application.

### FEATURES AND BENEFITS

- ▶ Increase productivity, reduce labor time and costs. Silicone free, enhance final high gloss surface finish.
- ▶ Avoids swirl and bloom marks as well as holograms when used with our random orbital polishers.

### TARGET MARKETS

- ▶ AAM, AOEM, Aerospace, Wind Energy, Metal Fabrication, Wood Working, Marine.

Container	Packaging	Color	P/N
Bottle	1 Liter	Teal	22011
Jug	5 Liters		22013



INFORMATION

## DYNAORANGE - VERY FINE FINISH

### APPLICATIONS

- ▶ Ideal polish for the second step of our Dynabrade "Two-Step" System when used with the corresponding foam and random orbital polisher. Leaves a high gloss, hologram free surface finish on all type of Automotive clearcoats.
- ▶ Final finish operation combined with more aggressive compounds.

### FEATURES AND BENEFITS

- ▶ Increase productivity, reduce labor time and costs. Silicone free, enhance final high gloss surface finish.
- ▶ Avoids swirl and bloom marks as well as holograms when used with our random orbital polishers.

### TARGET MARKETS

- ▶ AAM, AOEM.

Container	Packaging	Color	P/N
Bottle	1 Liter	Orange	22021



INFORMATION

## DYNABRADE DENIBBING DISCS – SILICON CARBIDE – FILM BACKING

### DYNABRADE DENIBBING DISCS : FILM BACKED, SILICON CARBIDE, PSA

#### APPLICATIONS

- ▶ For use with Dynabrade Denibber tools in wet/damp operations to remove nibs from paint and lacquers

#### FEATURES

- ▶ Even and consistent tri-dimensional coating
- ▶ Silicon carbide mineral
- ▶ T3: Structured abrasive type sanding disc for a more constant cut and longer lifetime
- ▶ T4: Coated abrasive type sanding disc for an excellent but aggressive cut

#### BENEFITS

- ▶ Fast removal of nibs without wild scratches
- ▶ Superior and even finish

Diameter	Grit	P/N	Quality	Qty/Box*
32 mm	A3	22672	T3	500 per roll
	A5	22670		
	A7	22671		
	A9	22669		100 per tube
	A3	22772		
	A5	22770		
75 mm	A7	22771		200 per roll
32 mm	P1500	71360	T4	500 per tube
	P2000	71361		
	P3000	71362		

INFO : A9 = P1500 - A7 = P2500 - A5 = P3000 - A3 = P4000

\*sold only per pack

INFORMATION



## POLISHING PADS & FOAMS – TERRY CLOTH, SYNTHETIC WOOL AND SHEEP SKIN | 1 ITEM PER BOX

#### TERRY CLOTH

- ▶ The most aggressive polishing pad. To be used to (Mirror)polish Chrome and Aluminum parts.

#### SHEEPSKIN

- ▶ Less aggressive than Terry Cloth pad. To be used to refresh old, hard and weathered surfaces.

#### SYNTHETIC WOOL

- ▶ Less aggressive than Sheepskin pad. To be used to polish weathered and dull painted surfaces and plastics.

#### MICROFIBER

- ▶ Less aggressive than Synthetic Wool pad. To be used to remove small scratches on paints, plastics and clearcoats.

INFORMATION



## CYLINDRICAL RETICULATED POLISHING FOAMS

- ▶ High performance foams in different densities.
- ▶ Ideal for random orbital polishing applications.
- ▶ Pineapple shaped to avoid that compound will splash around.
- ▶ Strong & Heat resistant cell structure for long lifetime.
- ▶ Oversized diameter to avoid that back-Up pad will touch surface.
- ▶ 25 mm thick with Radius edge to achieve smooth surface results.
- ▶ Grey=Hard, Blue=Medium, Black=Soft.

P/N	Backing pad diameter (mm)	Outer foam diameter (mm)	Description	Holes	Qty/Pack
72801	75	80	Cylindrical polishing Foam Black	0	Tube 20 pcs
72800			Cylindrical polishing D-Foam Black		
73100			Cylindrical polishing Foam Blue	6	
73101			Cylindrical polishing Foam Grey	0	
73400	75	80	Cylindrical Polishing Foam Black - Bulk Only	6	240
72802			Cylindrical Polishing Foam Blue - Bulk Only	0	
73200			Cylindrical Polishing Foam Grey - Bulk Only	6	
24507			Cylindrical Polishing Foam Black - Bulk Only	0	
73500	125	135	Cylindrical Polishing Foam Grey - Bulk Only	6	5
72901			Cylindrical polishing Foam Black	0	
73201			Cylindrical polishing Foam Blue		
73501			Cylindrical polishing Foam Grey		
73001	150	180	Cylindrical polishing Foam Black	0	2
73301			Cylindrical polishing Foam Blue		
73601			Cylindrical polishing Foam Grey		

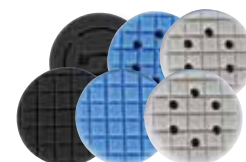

Diameter	Material	MOS	P/N	Product Name	Qty/Box*
80 mm	Terry cloth	5,000 RPM	90027	Polishing Pad	1
	Synthetic Wool		90028		
	Sheep skin		90080		
135 mm	Sheep skin	3,400 RPM	90081		
180 mm		2,500 RPM	90082		
200 mm	Synthetic Wool		90083		
80 mm	Microfiber	12,000 RPM	56150	20	
135 mm		10,000 RPM	73502	5	
180 mm		3,400 RPM	73602	2	



## CONICAL RETICULATED POLISHING FOAMS

- ▶ High performance foams in different densities.
- ▶ Ideal for Random Orbital polishing applications.
- ▶ Pineapple shaped to avoid that compound will splash around.
- ▶ Center hole to reduce friction caused by eccentric movement.
- ▶ Strong & Heat resistant cell structure with stiff interface layer for long lifetime.
- ▶ Oversized conical diameter to avoid that back-Up pad will touch workpiece.
- ▶ 20 mm thick with Radius edge to achieve smooth and hologram-free surface results.
- ▶ Grey=Hard, Green=Hard/Medium, Blue=Medium/soft, Black=Soft.

Product Name	Material	Holes	P/N	Size	Type	Qty/Box*
Conical blue	Reticulated foam	0	74017	45 mm	Polishing Foams	50
Conical green			74018			
Conical grey			74019			
Conical blue	Reticulated foam	6 + 1	74003	87 mm	Polishing Foams - Bulk Only	240
Conical green			74004			
Conical grey			74005			
Conical green	Reticulated foam	1	74006	87 mm	Polishing Foams - Bulk Only	240
Conical black			74020			
Conical black	Reticulated foam	1	74000	87 mm	Polishing Foams	5
Conical blue			74001			
Conical grey			74002			
Conical black	Reticulated foam	1	74009	138 mm	Polishing Foams	5
Conical blue			74010			
Conical green			74011			
Conical grey	Reticulated foam	1	74012	160 mm	Polishing Foams	2
Conical black			74013			
Conical blue			74014			
Conical green			74015			
Conical grey			74016			



## 5 LITERS CONTAINER ACCESSORIES – DISPENSER OR HOLDER | 1 ITEM PER BOX

Product	Material	Part Number	Color
Dispenser	Plastic	22005	White
Holder	Metal	22006	-



## MICROFIBER WIPES – IDEAL FOR DYNABRADE’S “TWO-STEP” SYSTEM

### APPLICATIONS

- ▶ Fast and complete removal of polish and paste residual after buffing/polishing.

### FEATURES AND BENEFITS

- ▶ Silicone free. Excellent absorbency and quick drying.
- ▶ No edges (art. 22050) – totally scratch-free because there is no sewing tread (art. 22000: sewn edges).
- ▶ Transparent printing – special print is scratch-free with no damage to sensitive surfaces.

INFORMATION

Color	Size	Part Number	Qty/Box
Blue & Yellow*	40 x 40 mm	22000	20
Orange	40 x 40 mm	22050	20



\* Package includes 10x Blue & 10x Yellow colors can not be ordered individually

## POLISHING FOAM TUBE HOLDER – HOLDS TWENTY 80 MM POLISHING FOAMS | 1 ITEM PER BOX

Material	Part Number	Size
Metal	22008	94 x 548 mm

For cylindrical Foams 80 mm only



**DYNAMIRROR – METAL POLISHING PASTE | 1 ITEM PER BOX****APPLICATIONS**

- ▶ Mirror polishing of stainless steel, brass and bronze.

**FEATURES AND BENEFITS**

- ▶ Easily removes small scratches from previous working passage.
- ▶ Gives a brilliant mirror finish.

**TARGET MARKETS**

- ▶ Metal Fabrication, Casting and Forging.

**INFORMATION**

Finish	Material	Part Number	Color
Very Fine	Paste	22024	Blue



## TIPS AND TECHNIQUES FOR POLISHING WITH DYNABRADE COMPOUNDS AND PADS / FOAMS

### HOW AND WHEN SHOULD THE POLISHING PADS BE CLEANED?

- ▶ If the pad begins to dust or stick during polishing, it is time to clean and remove the accumulated dirt and used polish from it. After polishing, all pads can be washed with water and a little cleaning agent. Note that lambskin pads should be left wet and re-attached to the hook face of polishing plate in order to prevent them from shrinking and losing their shape.

### THE POLISH OFTEN SPLATTERS WHEN I USE THE POLISHER. WHAT AM I DOING WRONG?

- ▶ This can be caused by various reasons:
  - a) The polisher is turned on before bringing the pad into contact with the paint (frequent beginner's error).
  - b) Polisher speed too high.
  - c) Too much polish.
  - d) Tilting of polisher / formation of dust when polishing edges.
  - e) Use of new pad that has not yet been worn in.
  - f) Fresh pad, into which the polishing compound has not been distributed evenly prior to polishing.

### CONSIDERATIONS WHEN USING A NEW POLISHING PAD

1. Make sure that the entire surface of each new pad is coated sparingly and evenly with the required polish. (Note: Any part of the pad that is not coated with polish may cause micro-scratches.)
2. The rubbing compound should be spread across several points onto the paint surface with the pad and then distributed evenly and rubbed in (BEFORE TURNING ON THE POLISHER). The aim is to have sufficient unused rubbing compound over the entire surface in order to ensure a uniform cut.
3. Now set the polisher/pad onto the paint surface and check whether you have set the polisher to the right speed.
4. Always START the polisher ON the surface and STOP the polisher OFF the surface.
5. The actual polishing process can now begin. Switch on the polisher.

IMPORTANT: you do not need to exert heavy downward force to keep the back-up pad and abrasive flat on the surface.

6. Make sure that the area of the surface you wish to work on is not too large. Always remember: you should be able to cover the selected surface from one comfortable position. Do not reach or extend beyond a comfortable range. You want to be able to keep uniform pressure across the entire area being polished. A 50 x 50 cm area is a common size to work at one time.
7. Follow a set pattern when buffing. It is suggested to pass over the surface, following a criss-cross "North, South, East, West" pattern, overlapping each pass by 50% of the diameter of the pad. (see diagram below) This ensures that a uniform finish is achieved. (See Figure A)

Check your progress and completely clean the surface with new microfiber towel. Wipe in a straight motion (not circular) to be able to detect any areas that might need additional work. If any defects are noticed, reapply compound to the pad and continue in that area until the surface is free of all defects. Always clear away and completely remove any polishing compound residues before progressing to the next area or polishing step. Do not use the same microfiber towel for different grades of compound.



22021

22017

22011

23040



Terry Cloth

Synthetic Wool

Sheep Skin

Figure A

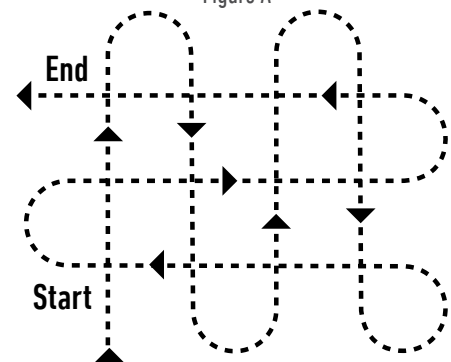

# MICROABRASIVES & SUPERABRASIVES

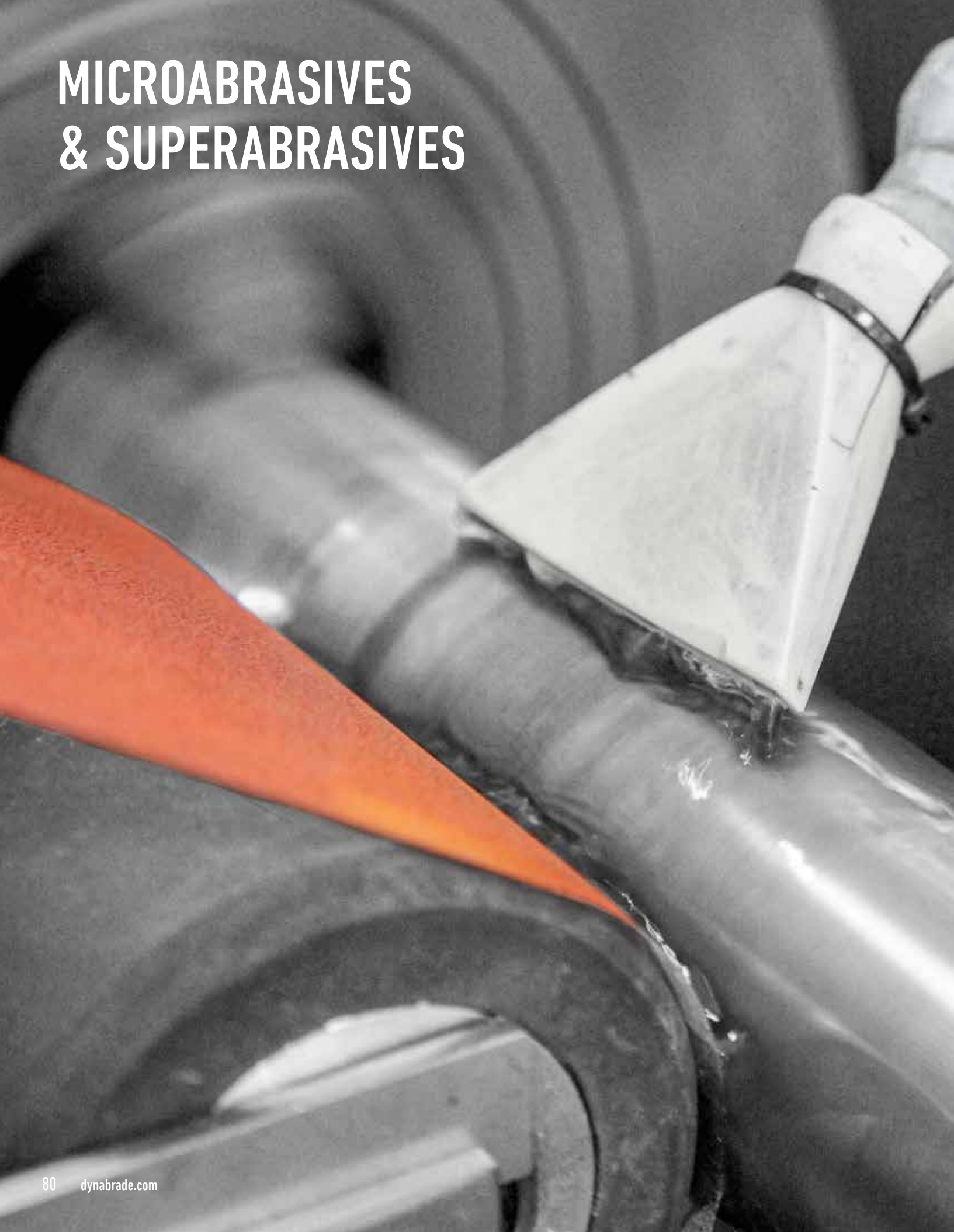



## MICROABRASIVES

Microfinishing and Lapping Films | Rolls for use on Dynabrade Superfinisher | Sheets for hand use.

### NOTES

- ▶ Microfinishing Film: For stock removal operations & intermediate finishes, or when required surface roughness is within certain limits.
- ▶ Lapping Film: For finer finishes when the required surface roughness is very low.

### APPLICATIONS

- ▶ Microabrasives are used for superfinishing and lapping applications, usually on a Superfinisher machine but also on specific machines for peculiar applications (e.g. superfinishing and lapping of camshafts and crankshafts).

### FEATURES AND BENEFITS

- ▶ Minerals commonly used are aluminum oxide (for general purpose applications on metals and hard plastics) and silicon carbide (for applications on soft plastics and rubber).
- ▶ Microfinishing and lapping films are also available with synthetic diamond mineral, for superfinishing and lapping applications on very hard materials like ceramic coatings, hard steel alloys, or hard chrome coatings.

### TARGET MARKETS

- ▶ AOEM, General Industry, Plasma Coated Material Refining, Rotogravure.

INFORMATION

## DLF 300 LAPPING FILM ROLLS – ALUMINUM OXIDE / FILM BACKING



Size	Grit	Backing	P/N	Qty/Box
50 mm x 50 m	40 MIC	3 MIL	71271	1
	30 MIC		71272	
	20 MIC		71273	
	16 MIC		71274	
	12 MIC		71275	
	9 MIC		71276	
	5 MIC		71277	
	3 MIC		71278	
	100 mm x 50 m		40 MIC	
30 MIC		73254		
20 MIC		73255		
15 MIC		73256		
12 MIC		73956		
9 MIC		73257		
5 MIC		22611		

Size	Grit	Backing	P/N	Qty/Box
200 mm x 50 m	40 MIC	3 MIL	71279	1
	30 MIC		71280	
	20 MIC		71281	
	16 MIC		71282	
	12 MIC		71283	
	9 MIC		71284	
	5 MIC		71285	
	3 MIC		71286	

## DCLF 300 DIAMOND SILICON CARBIDE LAPPING FILM ROLLS

Size	Grit	Backing	P/N	Qty/Box
100 mm x 45 m	30 MIC	3 MIL	73283	1
	15 MIC		73284	
	9 MIC		73285	
	5 MIC		73286	
	3 MIC		73287	
	1 MIC		73275	

## DMF 500 MICROFINISHING FILM ROLLS - ALUMINUM OXIDE / FILM BACKING FILM ROLLS

Size	Grit	Backing	P/N	Qty/Box
50 mm x 50 m	100 MIC	5 MIL	71303	1
	60 MIC		71304	
	50 MIC		71305	
	40 MIC		71306	
	30 MIC		71307	
	20 MIC		71308	
	15 MIC		71309	
	9 MIC		71310	
100 mm x 50 m	60 MIC	5 MIL	73352	1
	40 MIC		73353	
	30 MIC		73354	
	20 MIC		73355	
	15 MIC		73356	
	9 MIC		73357	
200 mm x 50 m	100 MIC	5 MIL	71311	1
	60 MIC		73266	
	40 MIC		73267	
	30 MIC		73366	
	20 MIC		73268	
	15 MIC		73358	
	9 MIC		73367	



Size	Grit	Backing	P/N	Qty/Box
200 mm x 50 m	30 MIC	5 MIL	73755	1
	15 MIC		73377	
	9 MIC		73378	
100 mm x 50 m	40 MIC	5 MIL	22755	1
	30 MIC		22756	
	20 MIC		22757	
	15 MIC		22758	

## DMF 300 MICROFINISHING FILM ROLLS - ALUMINUM OXIDE / FILM BACKING

Size	Grit	Backing	P/N	Qty/Box
100 mm x 50 m	60 MIC	3 MIL	73360	1
	40 MIC		73361	
	30 MIC		73362	
	20 MIC		73363	
	15 MIC		73364	
	9 MIC		73365	



## DDMF 500 DIAMOND MICROFINISHING FILM ROLLS

Size	Grit	Backing	P/N	Qty/Box
100 mm x 25 m	45 MIC	5 MIL	73383	1

## DDMF 400 DIAMOND MICROFINISHING FILM ROLLS

Size	Grit	Backing	P/N	Qty/Box
50 mm x 15 m	125 MIC	4 MIL	71287	1
	100 MIC		71288	
	74 MIC		71289	
	60 MIC		71290	
	45 MIC		71291	
	30 MIC		71292	
	20 MIC		71293	
	15 MIC		71294	
100 mm x 15 m	60 MIC	4 MIL	73260	1
	40 MIC		73388	
	30 MIC		73389	
	20 MIC		73390	
	15 MIC		73391	
	12 MIC		73392	
	9 MIC		73393	



Size	Grit	Backing	P/N	Qty/Box
200 mm x 15 m	125 MIC	4 MIL	71295	1
	100 MIC		71296	
	74 MIC		71297	
	60 MIC		71298	
	45 MIC		71299	
	30 MIC		71300	
	20 MIC		71301	
	15 MIC		71302	

## DDLDF 300 DIAMOND LAPPING FILM ROLLS

Size	Grit	Backing	P/N	Qty/Box
50 mm x 15 m	60 MIC	3 MIL	71251	1
	45 MIC		71252	
	40 MIC		71253	
	30 MIC		71254	
	15 MIC		71255	
	9 MIC		71256	
	6 MIC		71257	
	3 MIC		71258	
	1 MIC		71259	
	0,5 MIC		71260	
100 mm x 15 m	60 MIC	3 MIL	73348	1
	45 MIC		73351	
	40 MIC		73441	
	30 MIC		73442	
	15 MIC		73443	
	9 MIC		73444	
	6 MIC		73919	
	3 MIC		72842	
	1 MIC		24664	



Size	Grit	Backing	P/N	Qty/Box
200 mm x 15 m	60 MIC	3 MIL	71261	1
	45 MIC		71262	
	40 MIC		71263	
	30 MIC		71264	
	15 MIC		71265	
	9 MIC		71266	
	6 MIC		71267	
	3 MIC		71268	
	1 MIC		71269	
	0,5 MIC		71270	

## DYNAMOND SUPERABRASIVES

Size	P/N	Grit	Description	Qty/Box
75 mm	22565	Green N250	Dynamond Flexible Disc	1
50mm x 760 mm	73709	White 800 MB	Dynamond Flexible Sheet Canvas	1
230 mm x 280 mm	73419	Black N125	Dynamond Sheet PSA	1
	73719	Black N125	Dynamond Sheet Canvas	
	73816	Red N74		
	73640	White N20		
	73540	Yellow N40		
	73192	Black N125		
	73650	Black N125	Dynamond Sheet Velcro	
	73655	Blue R10	Dynamond Sheet PSA	
	73656	Green N250		
	73193	Red N74		
	73651	Red N74		
	73653	White N20		
	73652	Yellow N40	Dynamond Sheet Velcro	
	73654	Yellow/WhiteN30		
	100 mm x 3000/5000 mm	22323	Black N125	
22324		Red N74		



## DYNAMOND SPIRABAND

Size	Grit	Type	P/N	Description	Qty/Box
15 mm x 30 mm	Green N250	Ring	22830	Diamond Spiraband	1
	Black N125		22831		
	Red N74		22832		
30 mm x 30 mm	Green N250		22833		
	Black N125		22834		
50 mm x 42 mm	Green N250		22835		
	Black N125	22836			

## DYNAMOND STRIPS

Size	Grit	P/N	Qty/Box
100 mm x 3000/5000 mm	Grey N400	22889	1
	Green N250	22890	
	Black N125	22323	
	Red N74	22324	
	Yellow N40	22325	
	White N20	22326	



## DYNAMOND BELTS

Size	Grit	P/N	Qty/Box
13 mm x 457 mm	White N20	22924	1
	Black N125	24667	
13 mm x 610 mm	Red N74	22382	
	Yellow N40	22383	
19 mm x 457 mm	Black N125	22553	
	Black N125	73445	
25 mm x 762 mm	Yellow N40	22934	
	White N20	22935	
38 mm x 75 mm	Black N125	22891	
	Green N250	22691	
50 mm x 473 mm	Black N125	22939	
	White N20	72933	
50 mm x 1220 mm	Green N250	73025	
	Black N125	73026	
	Red N74	73027	
75 mm x 4000 mm	Black N125	24567	
	Grey N400	24591	



## DYNAMOND DISCS

Size	Grit	P/N	Attachment	Qty/Box
50 mm	Black N125	73452	Locking Type	1
100 mm		73461	Velcro	



# MISCELLANEOUS





## BI-METAL RECIPROCATING SAW BLADES

### NOTES

- ▶ 6 Teeth per Inch: Used for demolition work in nail-embedded wood; also for fast cutting of Composites.
- ▶ 10 Teeth per Inch: Used for demolition work in nail-embedded wood; also on pipe, stainless steel, carbon steel up to 6 mm thick.
- ▶ 18 Teeth per Inch: Used on pipe, stainless steel, carbon steel up to 4.5 mm thick.

### APPLICATIONS

- ▶ For use with Dynabrade Stockade Saws, for cutting and finishing metals, wood, plastics, carbon fibers, solid surface, etc.

### BENEFITS

- ▶ Shatter-resistant and excellent cut-rate.

### TARGET MARKETS

- ▶ Woodworking, Metal Fabrication, Marine, Composite.

INFORMATION

## BI-METAL RECIPROCATING SAW BLADES - 152 MM LONG

Teeth per Inch	Lenght x Width	P/N	Qty/Box
6	152 mm x Taper	90934	
8	152 mm x 19 mm	90939	1
18		90937	



## NITRO SAW BLADES

Teeth per Inch	P/N	Qty/Box
24 Tooth saw Blade	90928	1
32 tooth Saw Blade	90929	



# RECIPROCATING FILES - DOUBLE CUT SWISS PATTERN

## APPLICATIONS

- ▶ For precision finishing on delicate Parts and substrates. Also used for deburring and detail work.

## BENEFITS

- ▶ 2 sets of Diagonal rows of teeth.
- ▶ Excellent cut-rate.

## TARGET MARKETS

- ▶ Woodworking, Metal Fabrication, Marine and composites.

INFORMATION



Size	Tang	Shape	Cut	P/N	Qty/Box	
89 mm - 102 mm Long	3 mm	Rectangular	Straight	00 (Very Coarse)	90900	1
			Curved	0 (Coarse)	90901	
		Square	Straight	00 (Very Coarse)	90910	
			Curved	0 (Coarse)	90911	
		Three Square	Straight	00 (Very Coarse)	90920	
			Curved	0 (Coarse)	90921	
		Half Round	Straight	00 (Very Coarse)	90930	
			Curved	0 (Coarse)	90931	
		Crochet	Straight	00 (Very Coarse)	90940	
			Curved	0 (Coarse)	90941	
		Round	Straight	00 (Very Coarse)	90950	
			Curved	0 (Coarse)	90951	

Diameter	Tang	Shape	Cut	P/N	Qty/Box
152 mm	11 mm x 2.5 mm	Rectangular	0 (Coarse)	90985	1
	6 mm	Square	00 (Very Coarse)	90984	
	6 mm	Three Square		90983	
	6 mm	Half Round	0 (Coarse)	90988	
	6 mm x 2.8 mm	Round	00 (Very Coarse)	90981	
	6 mm			90982	



## DIAMOND CUT-OFF WHEELS - 3/32" THICKNESS | 1/8" DIAMOND GRIT WRAP

### NOTES

- ▶ Continuous Rim: Used most commonly for fiberglass cutting.
- ▶ Side Spoked: Used for sawing thicker material and curved surfaces, without jamming the wheel and stalling the tool.

### APPLICATIONS

- ▶ Utilized for fiberglass mold and flash trimming, plus trimming of composite components.

### FEATURES AND BENEFITS

- ▶ Long life, sharp and precise cut, no burrs.
- ▶ MOS 20.000 RPM

### TARGET MARKETS

- ▶ AOEM, Aerospace, Marine.

INFORMATION



Diameter	Attachement	Type	Thickness	P/N	Qty/Box
76 mm	3/8" Center Hole	Continuous Rim	3/32" (2.5 mm)	93917	1
		Side Spoked		93646	
		Gulleted / Slotted		93658	
	2-1/4" Shank	Continuous Rim		93906	
	2-1/4" Shank	Side Spoked		93907	
	102 mm	3/4" Center Hole		Side Spoked	
114 mm	3/8" Center Hole	Gulleted / Slotted	94912		
127 mm	3/4" Center Hole	Continuous Rim	93921		
		Side Spoked	93650		
		Gulleted / Slotted	93662		
180 mm	22 mm Hole	Segmented Rim	0.06" (1.5 mm)	94112	



Diamond cut-off wheels

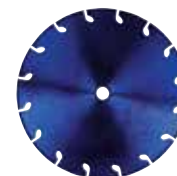

94112

## DIAMOND BLADES

Diameter	Attachement	Type	P/N	Qty/Box
75 mm	9 mm Hole	Continuous Rim	71400	1
		Side Spoked	71402	
100 mm		Continuous Rim	71401	
Side Spoked		71403		
125 mm	19 mm Hole	Side Spoked	71404	



71400

## COATED ABRASIVE BASICS – ABRASIVE TYPES

1

**CERAMIC ALUMINA C/A**

Ceramic Alumina is the most recent abrasive technology introduced in its first forms in the early 1980's. Chemical variations and special forming techniques continue to advance the use of this abrasive technology into more and more applications and material types.

2

The sub-micron structure of ceramic alumina allows each grain to continually expose sharp cutting points, resulting in a cooler cutting action and an extended life. It is the first choice for use on ferrous/non-ferrous metals, carbon steel and exotic alloys.

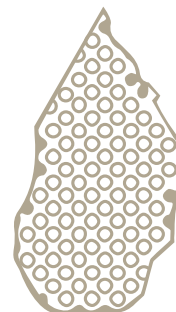

3

**ZIRCONIA ALUMINA Z/A**

Zirconia alumina is a super tough, man-made abrasive first introduced in the mid 1970's. It is tougher and sharper than aluminum oxide and retains its sharpness for a longer period. The microcrystalline structure ensures a more controlled breakdown, becoming self-sharpening resulting in a free, cool cut for high stock removal applications.

Ideal for heavy-duty grinding of all ferrous and non-ferrous metals, high stock removal on wood, plywood and particleboard, grinding fiberglass, rubber and plastics.



4

**ALUMINUM OXIDE A/O**

Aluminum Oxide was the second man-made abrasive to be invented. It is made in several versions including but not limited to Brown Aluminum Oxide, Light Brown Aluminum Oxide, White Aluminum Oxide and others.

Aluminum oxides run the gamut from very tough, block shaped and durable to hard, friable and very sharp. The result is an abrasives that can penetrate hard materials at high speeds for rapid stock removal. Aluminum oxides resist wear, generate a cool cutting action, provide long life and a freeness of cut on the widest range of materials.



5

**SILICON CARBIDE S/C**

Silicon carbide was the first man-made abrasives. It is the hardest and sharpest of the manufactured abrasives.

Blue/black in color, this abrasive grain enables fast stock removal and a cool cutting action on cast iron, non-ferrous metals, glass, rubber, plastic and stone. It is often used for final finishing on wood and creates the blue-bright finish on stainless steel.



## COATED ABRASIVE BASICS

### BOND TYPES

An adhesive bond or bond system is required to secure the abrasive grain to a backing. The majority of coated abrasive products are made with a two-stage bonding process while some unique polishing and lapping products being coated in one stage.

The make-coat and the size-coat are the two stages in most bonding processes. The make-coat is the initial layer of adhesive applied to the backing and allows for the precise placement of the abrasive grain onto the backing. This initial coating of make coat and grain is then dried to hold the grain in place. The size-coat is then applied over the abrasive mineral and make-coat and anchors the abrasive grain in place providing the desired physical strength of the finished product.

Adhesives include glue, urea resin, and phenolic resin are the three basic bonding agents most commonly used. There are numerous bond systems resulting from combinations of size-coat and make-coat adhesive like glue over glue, urea over glue, resin over glue and resin over resin. Glue over glue is the most flexible and oldest of the bond systems, while resin over resin bond is moisture-resistant, harder, less flexible, heat-resistant and has superior grain retention.

### COATING TYPES

There are two common types of abrasive coatings most often used in the manufacturing of coated abrasives: **OPEN COAT AND CLOSED COAT.**

- OPEN COAT** → **1** Coated abrasives made in an “open coat” have approximately 50% to 75% of the surface covered by abrasive grain. The evenly spaced voids between the particles of grain provide
- CLOSED COAT** → Coated abrasives made with a “closed” coating have virtually the entire surface of the backing covered with abrasive grain, with no voids between the particles. This is the most common coating, resulting in the most cutting tools available to produce the highest degree of stock removal and longest product life.

### COATED ABRASIVES STORAGE & HANDLING

When coated abrasives are stored under proper conditions they will retain their useful life and performance over a longer period of time. When stored inadequately coated abrasives can become brittle, curl excessively, the adhesive bonds can weaken and breakage can occur. Storage temperature and humidity are two of the most important factors affecting coated abrasive performance. Some backings and bonds are sensitive to heat and humidity and will gain or lose moisture quickly as the surrounding conditions change. Some adhesive bonds weaken when exposed to high humidity causing the coated abrasive surface to fill or clog more quickly and cut less aggressively reducing productivity. When exposed to low moisture conditions for extended periods of time, certain coated abrasives can become brittle, less flexible and distort from their original shapes. This is especially true with paper and fiber backed abrasives where increasing or decreasing moisture in the backing can cause dimensional changes. When moisture increases or decreases in the backing it usually occurs at a rate faster than the coating it causes cupping or curling. Film backed coated abrasives and synthetic cloth back coated abrasives are less susceptible to the effects of changes in humidity, however cold temperatures can create a condition where the product should be allowed to come up to ambient room temperatures before use.

Ideally coated abrasives should be stored in a separate room whose partitions do not include outside walls. Humidity should be maintained around 50% with a temperature between 60 and 80 degrees. Keep all coated abrasives in their original containers as they are received. Cartons and boxes should be kept off floors and away from cold walls where they could absorb moisture. They should be kept away from direct sources of heat or cold – radiators, steam pipes, heat and air conditioning ducts or rooms near other sources of heat like ovens or furnaces.

## COATED ABRASIVE BASICS - BACKING TYPES

### PAPER

The smooth surface of paper results in products that can generate a consistent finish. Paper backings range in weights and corresponding thicknesses from A-weight to F-weight with A being the thinnest and most flexible to F as the thickest most durable.

A, B, C and D weight - commonly used for hand sanding and light to moderate machine sanding in the form of sheets, PSA (pressure sensitive adhesive) and Hook and Loop discs and sheet rolls.

E and F weight - for more aggressive mechanical operations and are used most commonly in the form of belts and discs.

### CLOTH

Cloth backings are also identified by weight with the three most common being:

J-weight - most flexible

X-weight - a common heavy cloth that varies the most in flexibility, strength, and durability

Y-weight - heavyweight cloth expressly used for high stock removal operations.

Common cloth types used in coated abrasives are cotton, polyester, polyester, nylon, polyester/cotton blends, and rayon. Before it is coated with adhesives and abrasive grain, cloth backings first need to be filled or finished. A variety of fill or finishing materials are used to fill the voids and gaps in a woven cloth backing and can include

### FIBER

Vulcanized fiber (a process where cotton fibers are chemically treated and then pressed under temperature and pressure to form a very durable backing) is used as the backing for resin fiber discs.

### POLYESTER

Polyester film backings come in several thicknesses with 3 mil. and 5 mil. being the most commonly used for coated abrasives. Polyester films have high strength and are the smoothest of surfaces ensuring even coating. Film backed coated abrasives are most commonly used in disc shapes and rolls for applications requiring precise and consistent surface finish.



## GRIT GRADING SYSTEMS



ANSI or CAMI	FEPA (P-Grade)	Structured Abrasives	Micron	DynaBrite® Surface Conditioning
•	•	•	•	•
•	•	•	•	•
•	•	•	•	•
1500	•	•	•	•
1350	•	•	•	•
1200	•	•	•	•
•	P2500	•	6	•
1000	•	•	•	Ultra Fine
•	P2000	A6	10	•
•	•	•	•	•
800	P1500	•	12	•
600	•	•	15	Super Fine
•	P1200	A16	•	•
500	P1000	•	•	•
•	P800	•	22	•
400	•	•	30	•
•	P600	A30	•	•
360	•	•	•	•
•	P500	•	•	•
•	P400	•	35	•
320	•	•	•	Very Fine
280	P360	A45	40	•
240	•	•	50	Fine
•	P320	•	52	•
•	P280	•	•	•
•	•	•	•	•
•	P240	A65	•	•
220	P220	A80	60	•
180	P180	A100	80	•
150	•	•	100	Medium
•	P150	•	110	•
120	•	•	120	Coarse
•	P120	•	125	•
100	•	•	150	Extra Coarse
•	P100	•	•	•
80	•	•	180	•
•	P80	•	•	•
•	P60	•	•	•
60	•	•	•	•
•	P50	•	•	•
50	•	•	•	•
•	P40	•	•	•
40	•	•	•	•
•	P36	•	•	•
36	•	•	•	•
•	P30	•	•	•
30	•	•	•	•
24	•	•	•	•
•	P24	•	•	•

# CONVERSION TABLE

## LENGTH

	Meters	Centimeters	Millimeters
1 Inch (in.)	0.0254 m	2.54 cm	25.4 mm
1 Foot (ft.)	0.3048 m	30.48 cm	304.8 mm

## WEIGHT

	Kilograms	Grams
1 Ounce (oz.)	0.02835 kg	28.35 g
1 Pound (lb.)	0.454 kg	454 g

## POWER

	Kilowatts	Watts
1 hp	0.745 kW	745 W

## VOLUME

	Liters
1 US Gallon	3.785 l

## TORQUE

	Newton Meters
1 Inch-ounce	0.00706 Nm
1 Inch-pound	0.11298 Nm

## COMMON SIZES

Inches	Millimeters
3/32"	2.5 mm
1/8"	3 mm
3/16"	5 mm
1/4"	6 mm
3/8"	10 mm
1/2"	13 mm
3/4"	19 mm
1"	25 mm
1-1/4"	32 mm
2"	50 mm
2-3/4"	70 mm
3"	75 mm
3-1/2"	90 mm
4"	100 mm

Inches	Millimeters
4-1/2"	115 mm
5"	125 mm
6"	150 mm
7"	180 mm
8"	200 mm
9"	230 mm
11"	280 mm
12"	305 mm
18"	457 mm
20-1/2"	521 mm
24"	610 mm
30"	762 mm
34"	864 mm
44"	1118 mm

## COMMON RECTANGULAR SIZES (W X L)

Inches	Millimeters
4" x 4-5/16"	100 mm x 110 mm
4-1/4" x 4-1/12"	110 mm x 115 mm
2-3/4" x 8"	70 mm x 200 mm
2-3/4" x 11"	70 mm x 280 mm
3-2/3" x 7"	93 mm x 180 mm
2-7/8" x 3-1/8"	73 mm x 80 mm
2-3/8" x 3-3/4"	60 mm x 95 mm

Dynabrade reserves the right to update this catalogue without notice, updated versions available on [www.dynabrade.com](http://www.dynabrade.com)













WE LISTEN. WE OBSERVE. **WE OPTIMIZE.**



Dynabrade Europe S.à r.l  
Zone Artisanale Op Tomm, 6  
L-5485 Wormeldange-Haut, Luxembourg  
Tel: +352 768 494 1 / Fax: +352 768 495

Email: [customer.service@dynabrade.lu](mailto:customer.service@dynabrade.lu)  
[www.dynabrade.com](http://www.dynabrade.com)

Distributed By:

Dynabrade Abrasive System Products **EUR22-30**